

MAGNETIC OPERATING DEVICES

VS PRODUCT PORTFOLIO 2021



MAGNETIC OPERATING DEVICES

Due to their robustness, magnetic ballasts can be used in a wide array of operating conditions, ensuring dependable lighting applications and extended lifetime virtually anywhere.

Magnetic ballasts have proven to be the most reliable and widely used solution especially in extreme environments like high temperature peaks or very cold ambient temperatures, voltage peaks or vibrations.



Product Benefits

- **VERY LONG SERVICE LIFE**
- **EXTREMELY RELIABLE OPERATION**
- **LOW MAINTENANCE COSTS**

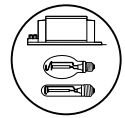

Standard Ballasts for HS and HI Lamps 35 to 250 W

Shape: 53x69 mm

For high pressure sodium lamps (HS),
metal halide lamps (HI) and
ceramic discharge lamps (C-HI)
Vacuum-impregnated with polyester resin
Screw terminals: 0.5–2.5 mm²
Protection class I
tw 130

Ballasts for pulse ignition system on request

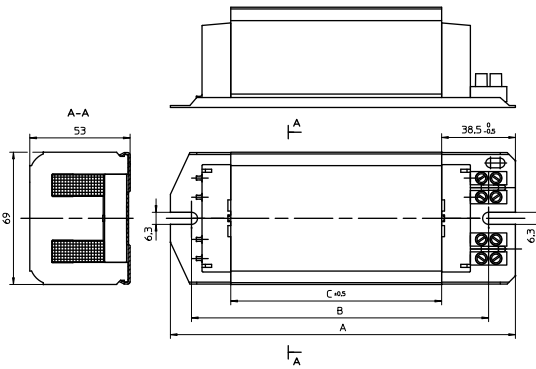
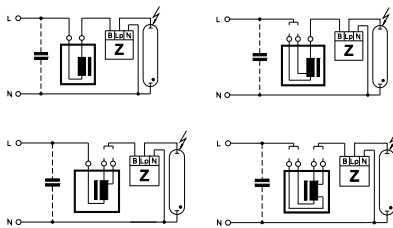
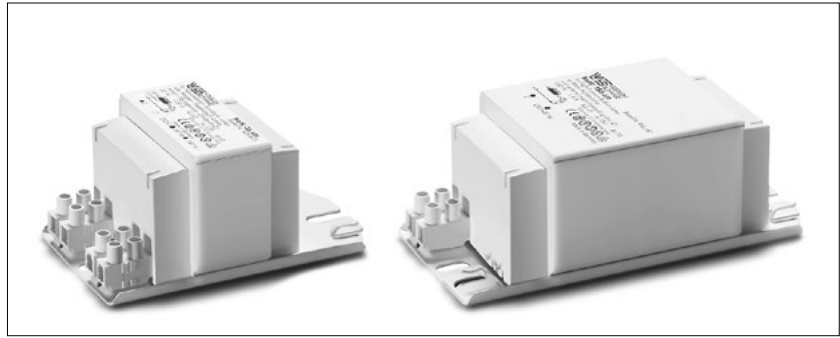

Lamp			Ballast										Capacitor	
Output W	Type	Current A	Type	Ref. No.	Voltage AC V, Hz	a mm	b mm	c mm	Weight kg	Δt K	Power factor λ	Energy efficiency	C _p μF	I _N A
35	HS, HI	0.53	NaHJ 35.485*	571074	230/240, 50	112	86	31	0.98	60	0.40	EEI=A3	6	0.22/0.21
			NaHJ 35.638	570961	220, 60	112	86	31	0.98	50	0.41	EEI=A3	5	0.23
50	HS, HI	0.76	NaHJ 50.486*	571077	230/240, 50	112	86	36	1.07	65	0.37	EEI=A3	8	0.30/0.29
			NaHJ 50.654	570958	220, 60	112	86	31	1.00	60	0.36	EEI=A3	8	0.31
70	HS, HI	0.98	NaHJ 70.300	570977	220, 50	112	86	36	1.12	75	0.40	EEI=A3	12	0.40
			NaHJ 70.128*	571008	230, 50	112	86	36	1.12	75	0.36	EEI=A3	12	0.38
			NaHJ 70.128*	571022	230/240, 50	112	86	36	1.15	75	0.36	EEI=A3	12	0.38/0.37
			NaHJ 70.128	571018	240, 50	112	86	36	1.15	75	0.37	EEI=A3	12	0.37
			NaHJ 70.653	570962	220, 60	112	86	36	1.05	75	0.42	EEI=A3	10	0.40
100	HS, HI	1.20	NaHJ 100.126	570997	220, 50	112	86	36	1.12	75	0.44	EEI=A3	12	0.55
			NaHJ 100.941*	570964	230/240, 50	112	86	36	1.15	75	0.42	EEI=A3	12	0.55/0.53
150	HS, HI	1.80	NaHJ 150.159	571004	220, 50	145	120	64	1.78	75	0.41	EEI=A3	20	0.80
			NaHJ 150.620*	571013	230, 50	145	120	64	1.83	75	0.40	EEI=A3	20	0.77
			NaHJ 150.620	571019	240, 50	145	120	64	1.85	75	0.40	EEI=A3	20	0.74
			NaHJ 150.679	570999	220, 60	145	120	64	1.72	75	0.44	EEI=A3	16	0.80
250	HS, HI	3.00	NaHJ 250.204	571006	220, 50	180	155	94	2.98	75	0.42	EEI=A3	32	1.32
			NaHJ 250.915*	570963	230, 50	180	155	110	2.95	80	0.40	EEI=A3	32	1.26
			NaHJ 250.340*	570982	230/240, 50	180	155	110	3.10	75	0.39	EEI=A3	32	1.26/1.21
			NaHJ 250.340	570978	240, 50	180	155	110	3.10	80	0.39	EEI=A3	32	1.21
			NaHJ 250.163	571249	220, 60	180	155	94	2.50	70	0.42	A2	25	1.35

* Ballasts without CE marking for replacements or markets outside of the EU

The values contained in this data sheet can change due to technical innovations. Any such changes will be made without separate notification.

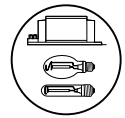

Ballasts with Thermal Cut-out for HS and HI Lamps 35 to 250 W



Shape: 53x69 mm

For high pressure sodium lamps (HS), metal halide lamps (HI) and ceramic discharge lamps (C-HI)
 Vacuum-impregnated with polyester resin
 With temperature switch with automatic reset
 Protection class I
 tw 130

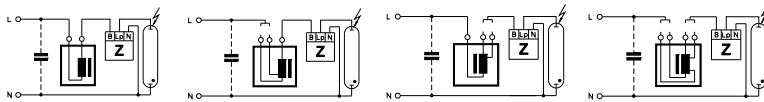
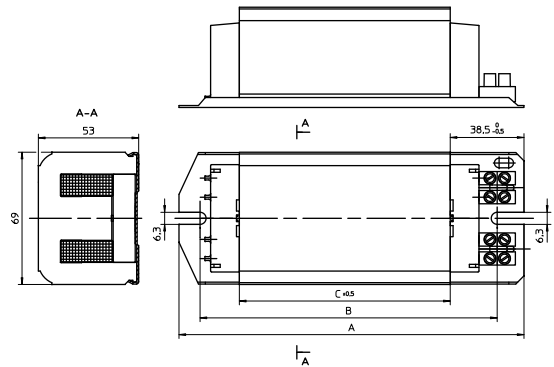

Lamp			Ballast										Capacitor	
Output W	Type	Current A	Type	Ref. No.	Voltage AC V, Hz	a mm	b mm	c mm	Weight kg	Δt K	Power factor (λ)	Energy efficiency	Cp μF	In A
Push-in terminals: 0.5–1.5 mm²														
35	HS, HI	0.53	NaHJ 35.209	571076	230/240, 50	112	86	36	1.10	35	0.36	A2	6	0.22
			NaHJ 35.485*	571075	230/240, 50	112	86	36	1.07	60	0.40	EEl=A3	6	0.22/0.21
50	HS, HI	0.76	NaHJ 70/50.157*	571081	230, 50	112	86	42	1.23	55	0.37	EEl=A3	8	0.30
70	HS, HI	0.98			70					70	0.37	EEl=A3	12	0.38
70	HS, HI	0.98	NaHJ 70.128*	571009	230, 50	112	86	36	1.12	75	0.36	EEl=A3	12	0.38
			NaHJ 70.226	571011	230, 50	112	86	41	1.28	60	0.37	A2	12	0.38
			NaHJ 70.158*	570995	230/240, 50	112	86	36	1.15	70	0.36	EEl=A3	12	0.38/0.37
150	HS, HI	1.80	NaHJ 150.995*	570994	230/240, 50	145	120	64	1.84	75	0.40	EEl=A3	20	0.77/0.74
Screw terminals: 0.5–2.5 mm²														
50	HS, HI	0.76	NaH 50.486*	571078	230/240, 50	112	86	36	1.07	65	0.37	EEl=A3	8	0.30
50	HS, HI	0.76	NaHJ 70/50.695*	571085	230/240, 50	112	86	48	1.23	50	0.37	EEl=A3	8	0.30/0.29
70	HS, HI	0.98			70					70	0.37	EEl=A3	12	0.38/0.37
70	HS, HI	0.98	NaHJ 70.226	571012	230, 50	112	86	41	1.28	60	0.37	A2	12	0.38
			NaHJ 70.128*	571010	230, 50	112	86	36	1.12	75	0.36	EEl=A3	12	0.38
			NaHJ 70.158*	570975	230/240, 50	112	86	36	1.15	70	0.36	EEl=A3	12	0.38/0.37
			NaHJ 70.128*	571020	230/240, 50	112	86	36	1.15	70	0.36	EEl=A3	12	0.38/0.37
100	HS, HI	1.20	NaHJ 100.213	571031	230/240, 50	112	86	45	1.38	65	0.41	A2	12	0.55/0.53
			NaHJ 100.941*	571028	230, 50	112	86	36	1.14	75	0.42	EEl=A3	12	0.55
			NaHJ 100.941*	570980	230/240, 50	112	86	36	1.15	75	0.42	EEl=A3	12	0.55/0.53
100	HS, HI	1.20	NaHJ 150/100.973*	571244	230, 50	145	120	75	2.02	55	0.41	A2	12	0.55
150	HS, HI	1.80			75					75	0.41	EEl=A3	20	0.77
150	HS, HI	1.80	NaHJ 150.166	571025	230/240, 50	180	155	110	3.08	50	0.40	A2	20	0.77/0.74
			NaHJ 150.620*	571015	230, 50	145	120	64	1.83	75	0.40	EEl=A3	20	0.77
			NaHJ 150.995*	570974	230/240, 50	145	120	64	1.84	75	0.40	EEl=A3	20	0.77/0.74
			NaHJ 150.620*	571023	230/240, 50	145	120	64	1.84	75	0.40	EEl=A3	20	0.77/0.74
250	HS, HI	3.00	NaHJ 250.915*	570993	230, 50	180	155	110	2.95	80	0.40	EEl=A3	32	1.26

* Ballasts without CE marking for replacements or markets outside of the EU

The values contained in this data sheet can change due to technical innovations. Any such changes will be made without separate notification.

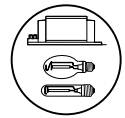

Ballasts for HS and HI Lamps 250 to 1000 W

Shape: 91x104 mm

For high pressure sodium lamps (HS), metal halide lamps (HI) and ceramic discharge lamps (C-HI)
 Vacuum-impregnated with polyester resin
 Screw terminals: 0.75–2.5 mm²
 Protection class I
 tw 130

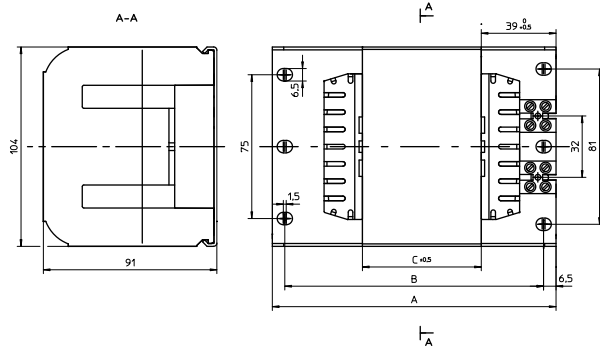
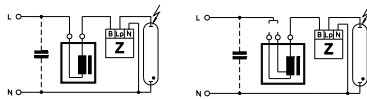

Lamp			Ballast										Capacitor	
Output W	Type	Current A	Type	Ref. No.	Voltage AC V, Hz	a mm	b mm	c mm	Weight kg	Δt K	Power factor λ	Energy efficiency	C _p μF	I _N A
250	HS, HI	3.00	NaHJ 250.727*	571042	230, 50	133	120	42	3.30	75	0.39	EEl=A3	32	1.26
			NaHJ 250.727	571049	240, 50	133	120	42	3.40	75	0.39	EEl=A3	32	1.21
400	HS, HI	4.45	NaHJ 400.006	571044	220, 50	148	135	62	4.57	75	0.44	A2	45	2.00
			NaHJ 400.006	571047	230, 50	148	135	62	4.57	80	0.44	A2	45	1.95
			NaHJ 400.737	571054	230/240, 50	148	135	62	4.7	75	0.45	A2	45	2.00/1.95
			NaHJ 400.737	571050	240, 50	148	135	62	4.61	80	0.43	A2	45	1.90
			NaHJ 400.012	571057	220, 60	148	135	68	4.45	75	0.44	A2	40	2.00
600	HS	6.20	NaH 600.010	571045	220, 50	173	160	96	6.78	75	0.44	A2	65	2.90
			NaH 600.005	571055	230/240, 50	173	160	96	6.89	75	0.44	A2	65	2.90/2.85
			NaH 600.140	571058	220, 60	173	160	96	6.79	75	0.46	A2	55	3.00
1000	HS	10.30	NaHJ 1000.089	571043	220, 50	248	235	160	11.31	75	0.47	A2	100	5.1
	HI	9.50							75	0.51	A2	85	5.0	
	HS	10.30	NaHJ 1000.089	571046	230, 50	248	235	160	11.4	75	0.45	A2	100	5.1
	HI	9.50							75	0.49	A2	85	5.0	
	HS	10.30	NaHJ 1000.089	571051	230/240, 50	248	235	160	11.57	75	0.45	A2	100	5.1
	HI	9.50							75	0.46	A2	85	5.0	
	HS	10.30	NaHJ 1000.089	571048	240, 50	248	235	160	11.45	75	0.42	A2	100	4.8
	HI	9.50							75	0.46	A2	85	4.9	
	HS	10.30	NaHJ 1000.089	571056	220, 60	248	235	160	11.13	75	0.46	A2	100	5.1
	HI	9.50							75	0.50	A2	85	5.0	

* Ballasts without CE marking for replacements or markets outside of the EU

With Thermal Cut-out

Thermal cut-out with automatic reset

Lamp			Ballast										Capacitor	
Output W	Type	Current A	Type	Ref. No.	Voltage AC V, Hz	a mm	b mm	c mm	Weight kg	Δt K	Power factor λ	Energy efficiency	C _p μF	I _N A
250	HS, HI	3.00	NaHJ 250.727*	571052	230/240, 50	133	120	42	3.40	75	0.39	EEl=A3	32	1.26/1.21
400	HS, HI	4.45	NaHJ 400.737	571053	230/240, 50	148	135	62	4.7	75	0.43	A2	45	1.95/1.90

* Ballasts without CE marking for replacements or markets outside of the EU

The values contained in this data sheet can change due to technical innovations. Any such changes will be made without separate notification.

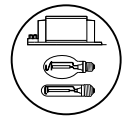

Ballasts for HI Lamps up to 2500 W

Shape: 150x150 mm

For metal halide lamps (HI)
 Vacuum impregnated with polyester resin
 Screw terminals: 0.75–4 mm²
 For luminaires of protection class I
 tw 130

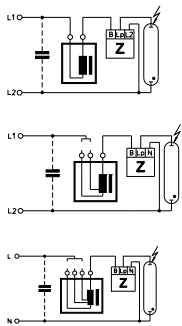

For Short Arc Lamps

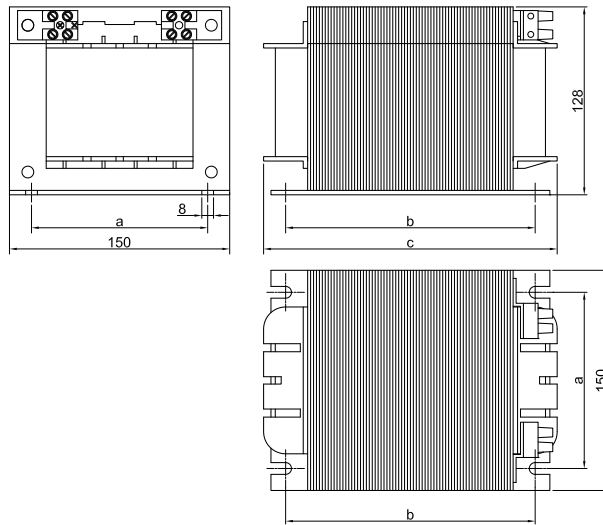

Lamp			Ballast										Capacitor	
Output W	Type	Current A	Type	Ref. No.	Voltage AC V, Hz	a mm	b mm	c mm	Weight kg	Δt K	Power factor λ	Energy efficiency	C _P μF	I _N A
2000	HI	8.8	J 2000.71	554303	380/400, 50	122	175	200	15	75	0.60	A2	37	6
			J 2000.72	554304	380/400/415, 50	122	135	160	14	70	0.58	A2	37	6
			J 2000.73	554305	380, 60	122	175	200	15	75	0.53	A2	30	6
2000	HI	10.3/11.3	JD 2000.81	554270	380/400, 50	122	175	200	15	80	0.53	A2	60	6
			JD 2000.81	554306	380/400/415, 50	122	135	160	14	75	0.52	A2	60	6
			JD 2000.83	554283	380, 60	122	175	200	15	75	0.54	A2	50	6
2000	HI	12.2	JD 2000III.91	554307	380/400, 50	122	175	200	16	80	0.46	A2	70	6
			JD 2000III.92	554308	380, 60	122	175	200	16	75	0.45	A2	60	6
2000	HI	16.5	JD 2000I.85	554309	230/240, 50	122	135	160	14	80	0.57	A2	125	10.5
			JD 2000I.86	554310	220, 60	122	135	160	14	80	0.57	A2	105	10
For Short Arc Lamps 1200 and 2500 W														
1200	HI	13.8	J 1200.95	554311	208, 60	122	105	130	11	-	0.40	A2	150	6
					230/245, 50									
2500	HI	25.6	J 2500.96	554312	208, 60	122	175	200	16	-	0.44	A2	260	12.3
					230/245, 50									

The values contained in this data sheet can change due to technical innovations. Any such changes will be made without separate notification.

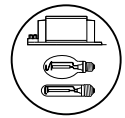

Ballast Units for HS and HI Lamps 1000 to 2000 W

Encapsulated in a plastic casing

For high-pressure sodium vapour lamps (HS) and metal halide lamps (HI)
Fully encapsulated ballast unit in a self-extinguishing, fibre-glass-reinforced polyamide casing consisting of a ballast, capacitor, fuse and a ready-to-use, pre-wired connection terminal.
Cable feed using a PG thread fitting

Degree of protection: IP65

With double insulation

Screw terminals: 0.75–10 mm²

Protection class II

tw 130

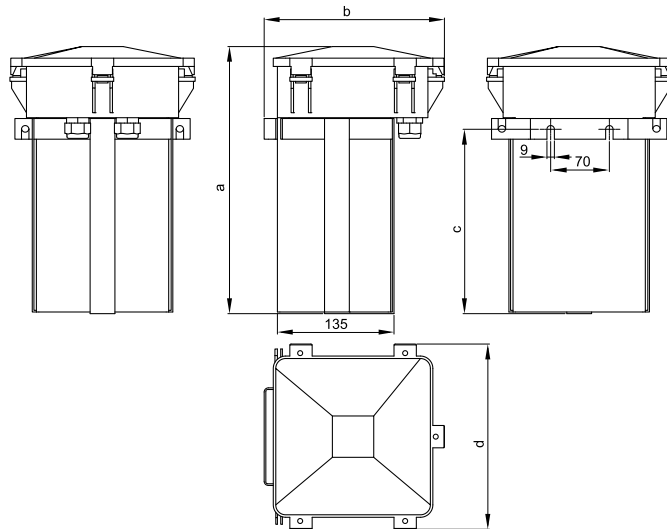

Lamp				Ballast unit									
Output W	Type	Current A	Mains current (A)	Type	Ref. No.	Voltage AC V, Hz	a mm	b mm	c mm	d mm	Weight kg	Power factor λ	Energy efficiency
230/240 V, 50 Hz and 380/400/415 V, 50 Hz													
1000	HS	10.3/11.3	5.75	VNaHj 1000.75	554313	230/240, 50	288	217	—	220	15	> 0.90	A2
	HI	9.5	4.9										A2
2000	HI	8.8/9.2	5.7	Vj 2000.76	554314	380/400/415, 50	320	217	225	225	21	> 0.90	A2
		10.3/11.3	6.0	VjD 2000.77	554315	380/400/415, 50	320	220	225	225	23	> 0.90	A2
		12.2	6.0	VjD 2000l.78	554316	380/400/415, 50	320	220	225	225	25	> 0.90	A2
220 V, 60 Hz and 380 V, 60 Hz													
1000	HS	10.3/11.3	5.75	VNaHj 1000.75	554904	220, 60	288	217	—	220	15	> 0.90	A2
	HI	9.5	4.9										A2
2000	HI	8.8/9.2	5.7	Vj 2000.76	554905	380, 60	320	220	225	225	21	> 0.90	A2
		10.3/11.3	6.0	VjD 2000.77	554906	380, 60	320	220	225	225	23	> 0.90	A2
		12.2	6.0	VjD 2000l.78	554909	380, 60	320	220	225	225	25	> 0.90	A2

The values contained in this data sheet can change due to technical innovations. Any such changes will be made without separate notification.

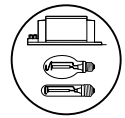

Ballasts for HM and HI Lamps 50 to 400 W

Shape: 53x69 mm

For mercury vapour lamps (HM) and metal halide lamps (HI) with ignition voltage 1 kV
Vacuum-impregnated with polyester resin
Screw terminals: 0.5–2.5 mm²
Protection class I
tw 130

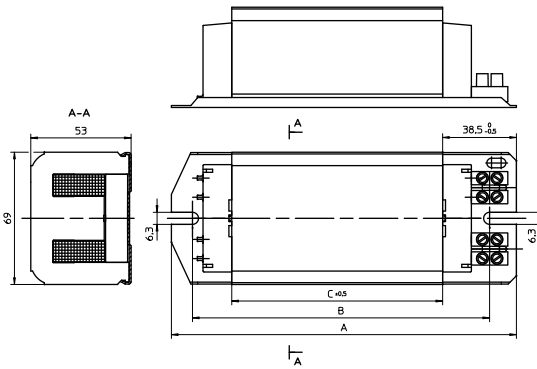
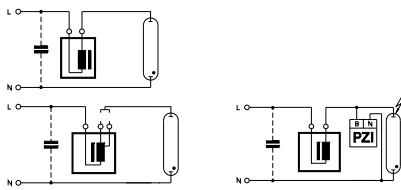
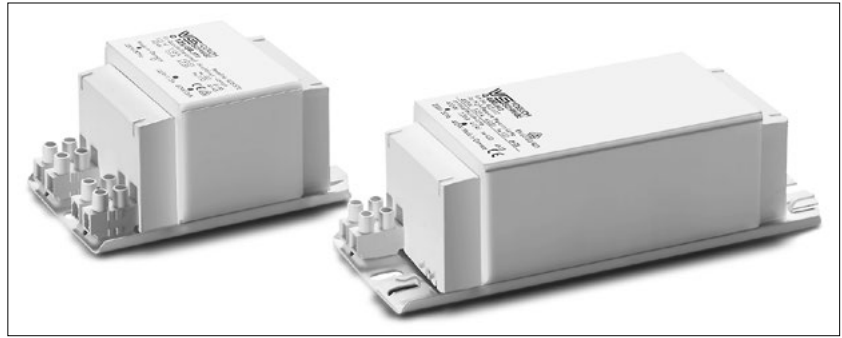

Lamp			Ballast										Capacitor	
Output W	Type	Current A	Type	Ref. No.	Voltage AC V, Hz	a mm	b mm	c mm	Weight kg	Δt K	Power factor λ	Energy efficiency	C _p μF	I _N A
50	HM	0.61	Q 80/50.551*	570968	230, 50	112	86	31	1.00	55	0.43	EEl=A3	7	0.27
80	HM	0.80								70	0.51	EEl=A3	8	0.41
80	HM	0.80	Q 80.510	570965	240, 50	112	86	31	1.00	60	0.48	EEl=A3	8	0.40
			Q 80.584	570970	220, 60	112	86	31	0.91	55	0.51	EEl=A3	7	0.43
80	HM	0.80	Q 125/80.611*	571080	230, 50	112	86	42	1.22	50	0.49	EEl=A3	8	0.41
125	HM	1.15								70	0.54	EEl=A3	10	0.60
125	HM	1.15	Q 125.549	570976	220, 50	112	86	31	0.94	75	0.56	EEl=A3	10	0.63
			Q 125.568*	570969	230, 50	112	86	36	1.10	75	0.54	EEl=A3	10	0.60
			Q 125.512	570966	240, 50	112	86	36	1.10	75	0.51	EEl=A3	10	0.58
			Q 125.598	570981	220, 60	112	86	31	0.94	75	0.57	EEl=A3	10	0.65
250	HM	2.13	Q 250.513	570967**	220, 50	145	120	64	1.84	75	0.58	A2	18	1.26
			Q 250.528	570972**	230, 50	145	120	64	1.86	75	0.56	A2	18	1.20
			Q 250.703	570996**	240, 50	145	120	64	1.87	75	0.53	A2	18	1.15
			Q 250.606	571003**	220, 60	145	120	64	1.75	75	0.58	A2	15	1.30
400	HM	3.25	Q 400.616	571000**	220, 50	180	155	110	2.94	75	0.60	EEl=A3	25	2.00
			Q 400.612	570971**	230, 50	180	155	110	3.00	75	0.56	A2	25	1.90
			Q 400.669	570973**	240, 50	180	155	110	3.07	75	0.54	A2	25	1.85
			Q 400.613	570998**	220, 60	180	155	94	2.54	75	0.60	A2	25	2.00

* Ballasts without CE marking for replacements or markets outside of the EU

** Suitable for metal halide lamps (HI) with ignition voltage 1 kV in combination with pulse ignitor PZI 1000/1 K

The values contained in this data sheet can change due to technical innovations. Any such changes will be made without separate notification.

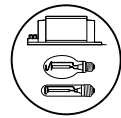

Ballasts for HM and HI Lamps 1000 W

Shape: 91x104 mm

For mercury vapour lamps (HM) and
metal halide lamps (HI) with ignition voltage 1 kV
Vacuum-impregnated with polyester resin

Screw terminals: 0.75–2.5 mm²

Protection class I

tw 130

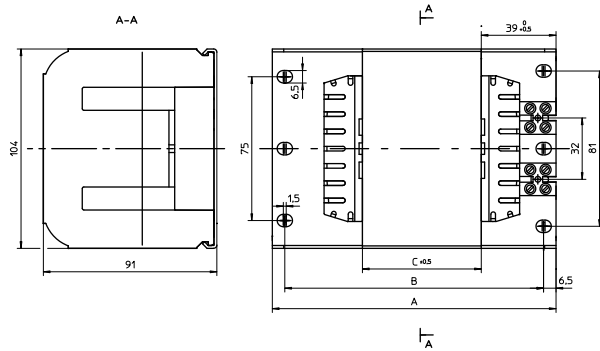
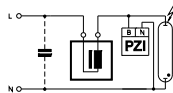
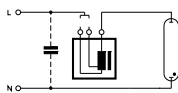
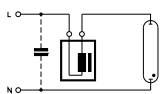

Lamp			Ballast										Capacitor	
Output W	Type	Current A	Type	Ref. No.	Voltage AC V, Hz	a mm	b mm	c mm	Weight kg	Δt K	Power factor λ	Energy efficiency	C _P μF	I _N A
1000	HM	7.50	Q 1000.097	571257*	220, 50	173	160	96	6.97	75	0.61	A2	60	4.80
			Q 1000.096	571255*	230, 50	173	160	96	6.94	75	0.60	A2	60	4.80
			Q 1000.145	571256*	240, 50	173	160	96	6.90	75	0.58	A2	60	4.60
			Q 1000.311	571254*	220, 60	173	160	96	6.74	75	0.61	A2	50	5.00

* Suitable for metal halide lamps (HI) with ignition voltage 1 kV in combination with pulse ignitor PZI 1000/1 K

The values contained in this data sheet can change due to technical innovations. Any such changes will be made without separate notification.

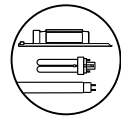

Standard Ballasts 4-16 W, 230/240/220 V

For fluorescent lamps
Shape: 28x41 mm

Vacuum-impregnated with polyester resin
Push-in terminal: 0.5-1.5 mm²
Protection class I
tw 130

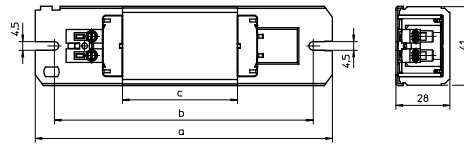
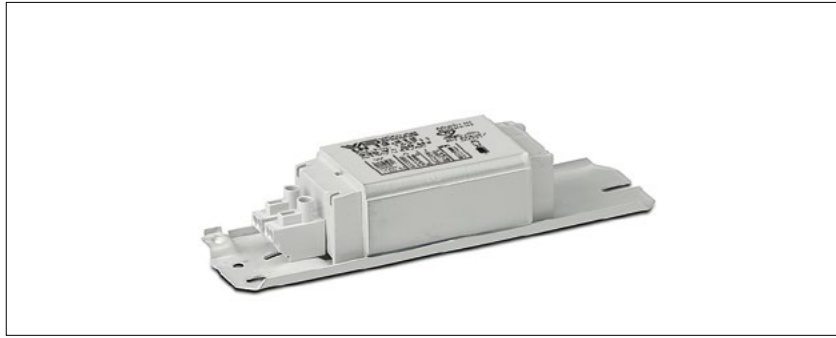

Lamp				Ballast										Capacitor	
Output W	Type	Base	Current mA	Type	Ref. No.	Voltage V, Hz	a mm	b mm	c mm	Weight kg	$\Delta t/\Delta t_{an}$ K	Energy efficiency	C _P µF	Current mA	
230 V, 50 Hz															
4	T5 (T16)	G5	170	L4/6/8.304*	163683	230, 50	105	87.5	34	0.32	55/85	B2	2.0	40	
2x4	T5 (T16)	G5	155	L4/6/8.304*	163683	230, 50	105	87.5	34	0.32	55/85	B1	2.0	50	
5	TC-S	G23	180	L7/9/11.307*	163694	230, 50	105	87.5	34	0.32	60/85	B2	2.0	50	
2x5	TC-S	G23	180	LN 13.313*	163711	230, 50	105	87.5	34	0.32	55/80	B2	2.0	70	
6	T5 (T16)	G5	160	L4/6/8.304*	163683	230, 50	105	87.5	34	0.32	55/85	B1	2.0	50	
2x6	T5 (T16)	G5	175	LN 13.313*	163711	230, 50	105	87.5	34	0.32	55/80	B1	2.0	65	
7	TC-S	G23	175	L7/9/11.307*	163694	230, 50	105	87.5	34	0.32	60/85	B2	2.0	50	
2x7	TC-S	G23	160	LN 13.313*	163711	230, 50	105	87.5	34	0.32	55/80	B2	2.0	70	
8	T5 (T16)	G5	145	L4/6/8.304*	163683	230, 50	105	87.5	34	0.32	55/85	B1	2.0	60	
2x8	T5 (T16)	G5	155	LN 13.313*	163711	230, 50	105	87.5	34	0.32	55/80	B1	2.0	85	
9	TC-S	G23	170	L7/9/11.307*	163694	230, 50	105	87.5	34	0.32	60/85	B1	2.0	60	
2x9	TC-S	G23	140	LN 13.313*	163711	230, 50	105	87.5	34	0.32	55/80	B2	2.0	80	
10	TC-D	G24d-1	190	LN 13.313*	163711	230, 50	105	87.5	34	0.32	55/80	B2	2.0	70	
	TC-DD	GR10q	180	LN 13.313*	163711	230, 50	105	87.5	34	0.32	55/80	B2	2.0	70	
11	TC-S	G23	155	L7/9/11.307*	163694	230, 50	105	87.5	34	0.32	60/85	B1	2.0	80	
13	TC-D/TC-T	G24d-1/GX24d-1	175	LN 13.313*	163711	230, 50	105	87.5	34	0.32	55/80	B2	2.0	80	
	T5 (T16)	G5	165	LN 13.313*	163711	230, 50	105	87.5	34	0.32	55/80	B1	2.0	80	
16	TC-DD	GR8/GR10q	195	LN 16.316*	163730	230, 50	105	87.5	34	0.32	60/125	B1	2.0	100	
240 V, 50 Hz															
5	TC-S	G23	180	L7/9/11.411	164335	240, 50	105	87.5	34	0.32	60/85	B2	2.0	50	
2x5	TC-S	G23	180	LN 13.413	164342	240, 50	105	87.5	34	0.32	60/90	B2	2.0	70	
2x6	T5 (T16)	G5	175	LN 13.413	164342	240, 50	105	87.5	34	0.32	60/90	B1	2.0	65	
7	TC-S	G23	175	L7/9/11.411	164335	240, 50	105	87.5	34	0.32	60/85	B2	2.0	50	
2x7	TC-S	G23	160	LN 13.413	164342	240, 50	105	87.5	34	0.32	60/90	B2	2.0	70	
2x8	T5 (T16)	G5	155	LN 13.413	164342	240, 50	105	87.5	34	0.32	60/90	B1	2.0	85	
9	TC-S	G23	170	L7/9/11.411	164335	240, 50	105	87.5	34	0.32	60/85	B1	2.0	60	
2x9	TC-S	G23	140	LN 13.413	164342	240, 50	105	87.5	34	0.32	60/90	B2	2.0	80	
10	TC-D	G24d-1	190	LN 13.413	164342	240, 50	105	87.5	34	0.32	60/90	B2	2.0	70	
	TC-DD	GR10q	180	LN 13.413	164342	240, 50	105	87.5	34	0.32	60/90	B2	2.0	70	
11	TC-S	G23	155	L7/9/11.411	164335	240, 50	105	87.5	34	0.32	60/85	B1	2.0	80	
13	TC-D/TC-T	G24d-1/GX24d-1	175	LN 13.413	164342	240, 50	105	87.5	34	0.32	60/90	B1	2.0	80	
	T5 (T16)	G5	165	LN 13.413	164342	240, 50	105	87.5	34	0.32	60/90	B1	2.0	80	

* Ballasts without CE marking for replacements or markets outside of the EU

The values contained in this data sheet can change due to technical innovations. Any such changes will be made without separate notification.

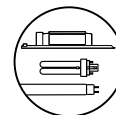

Standard Ballasts

14-65 W

230/240 V

For fluorescent lamps
Shape: 28x41 mm

Vacuum-impregnated with polyester resin

Push-in terminals: 0.5-1.5 mm²

(for 534584 screw terminals: 1-4 mm²)

Protection class I

tw 130

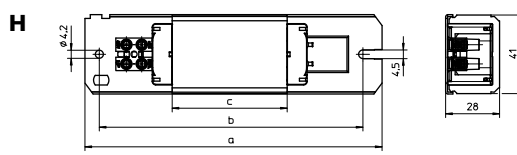
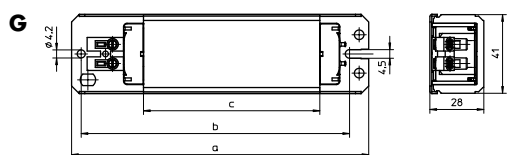
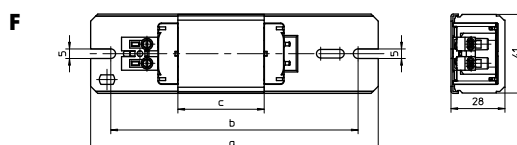
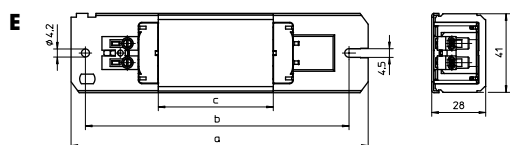
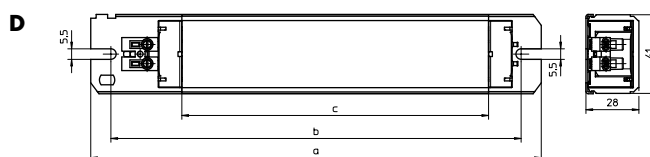
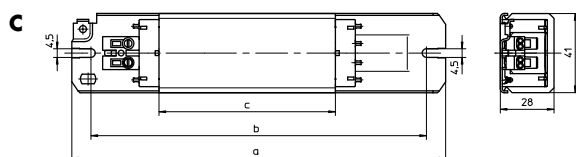
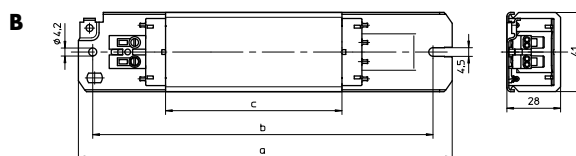
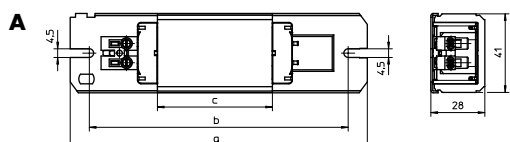
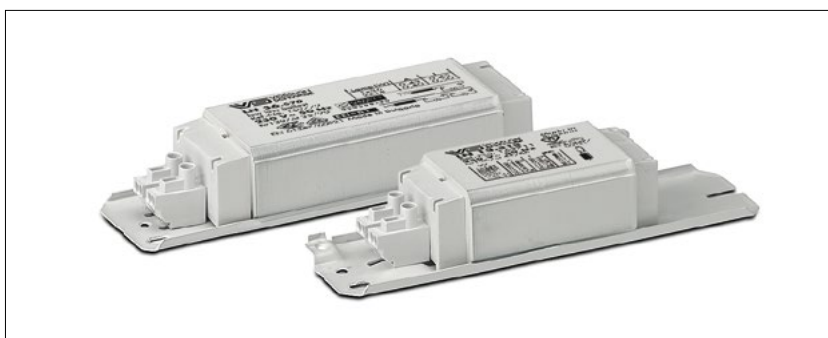

The values contained in this data sheet can change due to technical innovations. Any such changes will be made without separate notification.

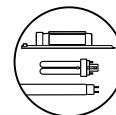

Standard Ballasts 14–65 W, 230/240/220 V

Lamp				Ballast										Capacitor		
Output	Type	Base	Current	Type	Ref. No.	Voltage	Draw- ing	a	b	c	Weight	$\Delta t/\Delta t_{an}$	Energy efficiency	C _p	Current	
W			mA			V, Hz		mm	mm	mm	kg	K		µF	mA	
230 V, 50 Hz																
14	T8 (T26)	G13	395	LN 18.510*	164572	230, 50	G	155	140	92	0.80	40/65	B2	4.5	150	
15	T8 (T26)	G13	310	LN 15.329*	163861	230, 50	E	155	138	60	0.55	50/80	B2	3.5	120	
2x15	T8 (T26)	G13	340	LN 30.801*	169645	230, 50	E	155	138	60	0.55	55/110	B2	4.0	185	
16	T8 (T26)	G13	200	LN 16.316*	163730	230, 50	A	105	87.5	34	0.32	60/125	B1	2.0	90	
18	TC-D/TC-T	G24d-2/GX24d-2	220	LN 18.319*	163763	230, 50	A	105	87.5	34	0.32	60/140	B1	2.0	110	
		TC-F/TC-L	2G10/2G11	370	LN 18.510*	164572	230, 50	G	155	140	92	0.80	40/65	B1	4.5	120
				LN 18.131*	530941	230, 50	E	155	138	60	0.55	55/95	B2	4.5	120	
	T-U	2G13	370	LN 18.131*	530941	230, 50	E	155	138	60	0.55	55/95	B2	4.5	120	
18/20	T8 (T26)/T12 (T38)	G13	370	LN 18.510*	164572	230, 50	G	155	140	92	0.80	40/65	B1	4.5	120	
				LN 18.131*	530941	230, 50	E	155	138	60	0.55	55/95	B2	4.5	120	
22	TR	G10q	400	LN 30.530*	164680	230, 50	G	155	140	92	0.80	45/65	B2	4.5	200	
25	T12 (T38)	G13	290	L 25.346*	164013	230, 50	E	155	138	60	0.55	45/80	B1	3.5	130	
26	TC-D/TC-T	G24d-3/GX24d-3	325	LN 18.131*	530941	230, 50	E	155	138	60	0.55	55/95	B1	3.5	140	
				LN 26.813*	509502	230, 50	A	110	100	45	0.41	55/145	B2	3.5	140	
28	TC-DD	GR8/GR10q	320	LN 18.510*	164572	230, 50	G	155	140	92	0.80	40/65	B1	3.5	150	
				LN 18.131*	530941	230, 50	E	155	138	60	0.55	55/95	B1	3.5	150	
30	T8 (T26)	G13	365	LN 30.801*	169645	230, 50	E	155	138	60	0.55	55/110	B2	4.5	180	
32	TR	G10q	450	LN 36.570*	169779	230, 50	G	155	140	92	0.80	35/90	B2	4.0	220	
36	TC-F/TC-L	2G10/2G11	430	LN 36.570*	169779	230, 50	G	155	140	92	0.80	35/90	B1	4.5	210	
				LN 36.511*	164590	230, 50	G	155	140	92	0.80	35/95	B1	4.5	210	
				LN 36.149*	529029	230, 50	E	155	138	60	0.55	55/150	B2	4.5	210	
				L 36.132*	535977	230, 50	F	150	129	45	0.43	65	—	4.5	210	
36-1	T8 (T26)	G13	556	L 36.132*	535977	230, 50	F	150	129	45	0.43	65	—	4.5	210	
				L 36.342*	538072	230, 50	B	195	180	110	0.87	50/120	B2	6.5	250	
36/40	T-U/TR	2G13/G10q	430	LN 36.570*	169779	230, 50	G	155	140	92	0.80	35/90	B1	4.5	210	
				LN 36.149*	529029	230, 50	E	155	138	60	0.55	55/150	B2	4.5	210	
				L 36.132*	535977	230, 50	F	150	129	45	0.43	65	—	4.5	210	
	T8 (T26)/T12 (T38)	G13	430	LN 36.570*	169779	230, 50	G	155	140	92	0.80	35/90	B1	4.5	210	
				LN 36.149*	529029	230, 50	E	155	138	60	0.55	55/150	B2	4.5	210	
				L 36.132*	535977	230, 50	F	150	129	45	0.43	65	—	4.5	210	
38	TC-DD	GR10q	430	LN 36.570*	169779	230, 50	G	155	140	92	0.80	35/90	B1	4.5	210	
				LN 36.149*	529029	230, 50	E	155	138	60	0.55	55/150	B2	4.5	210	
				L 36.132*	535977	230, 50	F	150	129	45	0.43	65	—	4.5	210	
	T8 (T26)	G13	430	LN 36.570*	169779	230, 50	G	155	140	92	0.80	35/90	B1	4.5	210	
				LN 36.149*	529029	230, 50	E	155	138	60	0.55	55/150	B2	4.5	210	
				L 36.132*	535977	230, 50	F	150	129	45	0.43	65	—	4.5	210	
58	T-U	2G13	670	LN 58.568*	169389	230, 50	D	235	220	160	1.31	35/95	B1	7.0	320	
				LN 58.116*	508186	230, 50	C	195	180	92	0.80	55/160	B2	7.0	320	
58/65	T8 (T26)/T12 (T38)	G13	670	LN 58.568*	169389	230, 50	D	235	220	160	1.31	35/95	B1	7.0	320	

* Ballasts without CE marking for replacements or markets outside of the EU

The values contained in this data sheet can change due to technical innovations. Any such changes will be made without separate notification.

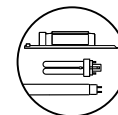

Standard Ballasts 14–65 W, 230/240/220 V

Lamp				Ballast										Capacitor	
Output	Type	Base	Current	Type	Ref. No.	Voltage	Drawing	a	b	c	Weight	$\Delta t / \Delta t_{an}$	Energy efficiency	C _p	Current
W			mA			V, Hz		mm	mm	mm	kg	K		µF	mA
240 V, 50 Hz															
18	TC-F/TC-L	2G10/2G11	370	L 18.936*	534627	240, 50	F	150	129	45	0.43	70/140	—	4.5	120
	T-U	2G13	370	L 18.936*	534627	240, 50	F	150	129	45	0.43	70/140	—	4.5	120
18/20	T8 (T26)/T12 (T38)	G13	370	L 18.936*	534627	240, 50	F	150	129	45	0.43	70/140	—	4.5	120
24	TC-F/TC-L	2G10/2G11	345	L 18.936*	534627	240, 50	F	150	129	45	0.43	70/140	—	4.5	150
28	TC-DD	GR8/GR10q	320	L 18.936*	534627	240, 50	F	150	129	45	0.43	70/140	—	3.5	150
36/40	T8 (T26)/T12 (T38)	G13	430	L 36.124	534584	240, 50	H	150	140	45	0.43	70/150	—	4.5	210
58	T-U	2G13	670	LN 58.722	534252	240, 50	C	195	180	92	0.80	60/180	B2	7.0	320
58/65	T8 (T26)/T12 (T38)	G13	670	LN 58.722	534252	240, 50	C	195	180	92	0.80	60/180	B2	7.0	320
220 V, 50 Hz															
18	TC-F/TC-L	2G10/2G11	370	L18.933	534624	220, 50	F	150	129	45	0.43	70/160	—	4.5	120
	T-U	2G13	370	L18.933	534624	220, 50	F	150	129	45	0.43	70/160	—	4.5	120
2x18	TC-F/TC-L	2G10/2G11	400	L 36.158	530252	220, 50	F	150	129	45	0.43	65	—	4.0	210
18/20	T8 (T26)/T12 (T38)	G13	370	L 18.933	534624	220, 50	F	150	129	45	0.43	70/160	—	4.5	120
2x18/20	T8 (T26)/T12 (T38)	G13	430	L 36.158	530252	220, 50	F	150	129	45	0.43	65	—	4.0	210
24	TC-F/TC-L	2G10/2G11	345	L18.933	534624	220, 50	F	150	129	45	0.43	70/160	—	4.5	150
26	TC-D/TC-T	G24d-3/GX24d-3	325	L18.933	534624	220, 50	F	150	129	45	0.43	70/160	—	3.5	140
28	TC-DD	GR8/GR10q	320	L18.933	534624	220, 50	F	150	129	45	0.43	70/160	—	3.5	150
36	TC-F/TC-L	2G10/2G11	430	L 36.158	530252	220, 50	F	150	129	45	0.43	65	—	4.5	210
36/40	T-U/TR	2G13/G10q	430	L 36.158	530252	220, 50	F	150	129	45	0.43	65	—	4.5	210
	T8 (T26)/T12 (T38)	G13	430	L 36.158	530252	220, 50	F	150	129	45	0.43	65	—	4.5	210
38	TC-DD	GR10q	430	L 36.158	530252	220, 50	F	150	129	45	0.43	65	—	4.5	210
	T8 (T26)	G13	430	L 36.158	530252	220, 50	F	150	129	45	0.43	65	—	4.5	210
58	T-U	2G13	670	L 58.625	164828	220, 50	C	195	180	92	0.80	55/155	—	7.0	320
58/65	T8 (T26)/T12 (T38)	G13	670	L 58.625	164828	220, 50	C	195	180	92	0.80	55/155	—	7.0	320
220 V, 60 Hz															
18	TC-F/TC-L	2G10/2G11	370	L 18.121	528582	220, 60	F	150	129	45	0.43	65/145	—	4.0	150
	T-U	2G13	370	L 18.121	528582	220, 60	F	150	129	45	0.43	65/145	—	4.0	150
2x18	TC-F/TC-L	2G10/2G11	400	L 36.120	509373	220, 60	F	150	129	45	0.43	60/170	—	4.0	210
18/20	T8 (T26)/T12 (T38)	G13	370	L 18.121	528582	220, 60	F	150	129	45	0.43	65/145	—	4.0	190
2x18/20	T8 (T26)/T12 (T38)	G13	430	L 36.120	509373	220, 60	F	150	129	45	0.43	60/170	—	4.0	220
24	TC-F/TC-L	2G10/2G11	345	L 18.121	528582	220, 60	F	150	129	45	0.43	65/145	—	4.0	190
26	TC-D/TC-T	G24d-3/GX24d-3	325	L 18.121	528582	220, 60	F	150	129	45	0.43	65/145	—	3.0	160
36	TC-F/TC-L	2G10/2G11	430	L 36.120	509373	220, 60	F	150	129	45	0.43	60/170	—	4.0	210
36/40	T-U/TR	2G13/G10q	430	L 36.120	509373	220, 60	F	150	129	45	0.43	60/170	—	4.0	220
	T8 (T26)/T12 (T38)	G13	430	L 36.120	509373	220, 60	F	150	129	45	0.43	60/170	—	4.0	220
38	TC-DD	GR10q	430	L 36.120	509373	220, 60	F	150	129	45	0.43	60/170	—	4.0	220
	T8 (T26)	G13	430	L 36.120	509373	220, 60	F	150	129	45	0.43	60/170	—	4.0	230
58	T-U	2G13	670	L 58.657	164870	220, 60	C	195	180	92	0.80	55/140	—	6.0	320
58/65	T8 (T26)/T12 (T38)	G13	670	L 58.657	164870	220, 60	C	195	180	92	0.80	55/140	—	6.0	320

* Ballasts without CE marking for replacements or markets outside of the EU

The values contained in this data sheet can change due to technical innovations. Any such changes will be made without separate notification.

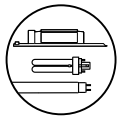

Super Low-loss Ballasts 18–65 W, 230 V

For fluorescent lamps
Shape: 28x41 mm

Vacuum-impregnated with polyester resin
Push-in terminal: 0.5–1.5 mm²

Protection class I

tw 130

**Energy efficiency: A2,
minimum EU energy efficiency
requirements as of 2017**

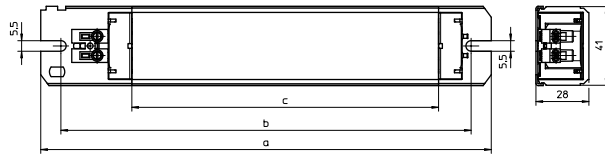

Lamp				Ballast										Capacitor	
Output	Type	Base	Current	Type	Ref. No.	Voltage	a	b	c	Weight	$\Delta t / \Delta t_{an}$	Energy efficiency	C _p	Current	
W			mA			V, Hz	mm	mm	mm	kg	K		μF	mA	
230 V, 50 Hz															
2x18/20	T8 (T26)/T12 (T38)	G13	400	LNN 36.648	560664	230, 50	235	220	160	1.35	25/40	A2	4.5	210	
36/40	T8 (T26)/T12 (T38)	G13	430	LNN 36.648	560664	230, 50	235	220	160	1.35	25/40	A2	4.5	210	
58/65	T8 (T26)/T12 (T38)	G13	670	LNN 58.960	569031	230, 50	235	220	160	1.35	50/80	A2	7.0	320	

The values contained in this data sheet can change due to technical innovations. Any such changes will be made without separate notification.