

$\phi 75$

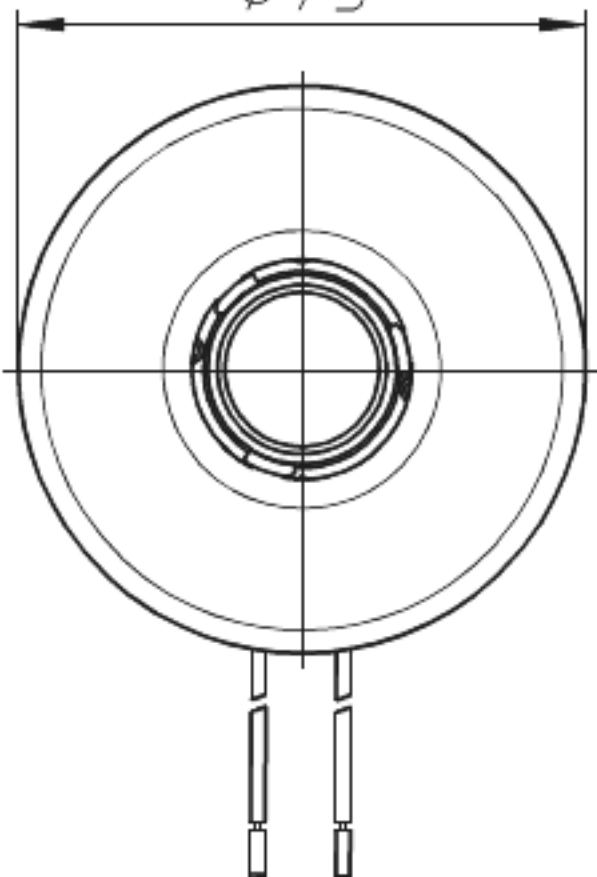

43,55

