

LED MODULES READYLINE DL

BUILT-IN MODULE



LED-MODULE READYLINE DOWNLIGHT DL

WU-M-538 / WU-M-539 / WU-M-540

Typical Applications

- Downlights
- Replacement for CFL

LED Modules ReadyLine DL

- **DIRECT MAINS CONNECTION**
- **REDUCED FLICKER**
- **HIGH POWER FACTOR**
- **HIGHLY EFFICIENT**
- **LES PROTECTION COVER FOR A SAFE LUMINAIRE**
- **APPROVED TO EUROPEAN STANDARDS**
- **VDE APPROVED**



LED Modules ReadyLine DL

Technical Notes

- LED built-in module for integration into luminaires 
- AC operation at 230 V
- Power factor: 0.99
- Dimensions
WU-M-538: Ø 164 mm
WU-M-539: Ø 250 mm
WU-M-540: Ø 350 mm
- Beam angle: 120°
- ReadyLine DL EM for Emergency Lighting
With separate LED circuit for operation with local VS emergency lighting drivers

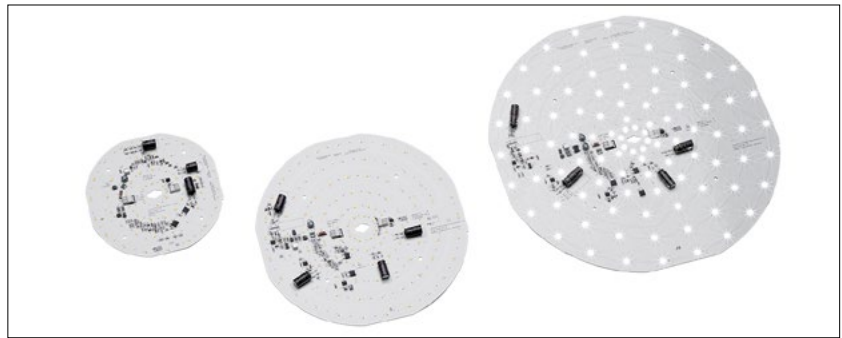

Typical Light Distribution Curve

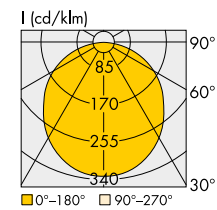

Electrical Characteristics

at $t_p = 50\text{ °C} / 230\text{ V AC}$

Type	Supply voltage AC $U_{typ.} / U_{operation}$ V	Operation frequency Hz	Power consumption at 230 V W	THD %	Power factor	Flicker percent %	Flicker index
WU-M-538	220–240	50/60	20.5	12	0.99	18	0.05
WU-M-539			30.5	12	0.99	16	0.05
WU-M-540			42.5	13	0.99	14	0.04

Maximum Ratings

Exceeding the maximum ratings can lead to reduction of service life or destruction of the modules.

Type	Operation voltage range (AC)		Operation temperature range at t_c point		Ambient temperature range		Storage temperature range	
	U min.	U max.	°C min.	°C max.	°C min.	°C max.	°C min.	°C max.
All types	205	264	-20	+80	-20	+45	-40	+85

Optical Characteristics

at $t_p = 50\text{ °C} / 230\text{ V AC}$

Typ. output W	Type	Ref. No.	Type EM*	Ref. No. EM*	Number of LEDs pcs.	Colour	Correlated colour temperature (K)	Typ. luminous flux (lm) and efficiency (lm/W)** at 230 V			Typ. CRI R_a	Energy efficiency
						min. (lm) typ. (lm) typ. (lm/W)						
ReadyLine DL 164			ReadyLine DL 164 EM									
20.5	WU-M-538-830	562159	WU-M-538-830-EM	561880	46	warm white	3000	2184	2237	113	80	A+
20.5	WU-M-538-840	562160	WU-M-538-840-EM	561881	46	neutral white	4000	2184	2350	119	80	A+
20.5	WU-M-538-850	562161	WU-M-538-850-EM	562162	46	cool white	5000	2184	2429	123	80	A+
ReadyLine DL 250			ReadyLine DL 250 EM									
30.5	WU-M-539-830	562163	WU-M-539-830-EM	561882	90	warm white	3000	3172	3503	112	80	A+
30.5	WU-M-539-840	562164	WU-M-539-840-EM	561883	90	neutral white	4000	3172	3617	116	80	A+
30.5	WU-M-539-850	562165	WU-M-539-850-EM	562166	90	cool white	5000	3457	3743	120	80	A+
ReadyLine DL 350			ReadyLine DL 350 EM									
42.5	WU-M-540-830	562167	WU-M-540-830-EM	562170	89	warm white	3000	4143	4663	110	80	A+
42.5	WU-M-540-840	562168	WU-M-540-840-EM	562171	89	neutral white	4000	4321	4841	114	80	A+
42.5	WU-M-540-850	562169	WU-M-540-850-EM	562172	89	cool white	5000	4499	5019	118	80	A+

* With separate LED circuit for operation with local VS emergency lighting drivers only

** Production tolerance of luminous flux and efficiency: $\pm 10\%$

Packaging unit: 64 pcs. (DL 164) / 22 pcs. (DL 250) / 16 pcs. (DL 350)

The values contained in this data sheet can change due to technical innovations. Any such changes will be made without separate notification.

LED Modules ReadyLine DL

Optical Characteristics for Emergency Lighting Operation

Typ. Output W	Type	Ref. No.	Number of LEDs pcs.	Typ. luminous flux* lm	Typ. voltage* DC (V)	Typ. current* mA
ReadyLine DL 164 EM						
3	WU-M-538-830-EM	561880	6	535	36	100
3	WU-M-538-840-EM	561881	6	560	36	100
3	WU-M-538-850-EM	562162	6	580	36	100
ReadyLine DL 250 EM						
3	WU-M-539-830-EM	561882	8	425	25	125
3	WU-M-539-840-EM	561883	8	440	25	125
3	WU-M-539-850-EM	562166	8	475	25	125
ReadyLine DL 350 EM						
3	WU-M-540-830-EM	562170	8	435	25	125
3	WU-M-540-840-EM	562171	8	455	25	125
3	WU-M-540-850-EM	562172	8	500	25	125

* Production tolerance of luminous flux, voltage and current: ±10%

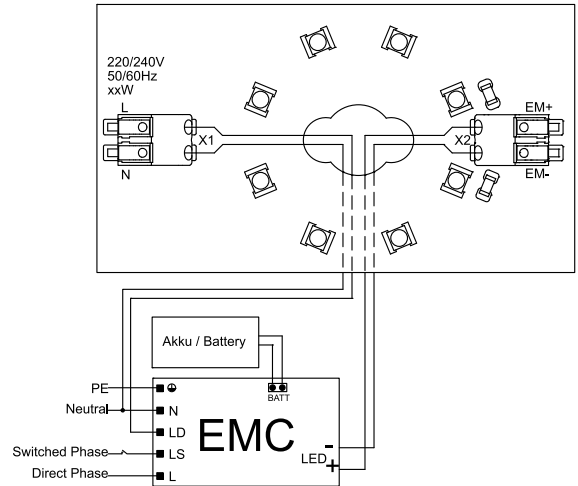

Operating Life

Lumen maintenance L70/B50:
50,000 hrs. at t_p 65 °C

Mechanical Dimensions

WU-M-538

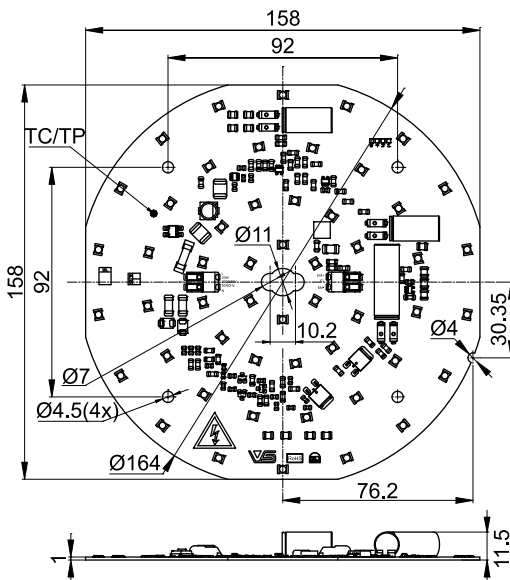

WU-M-539

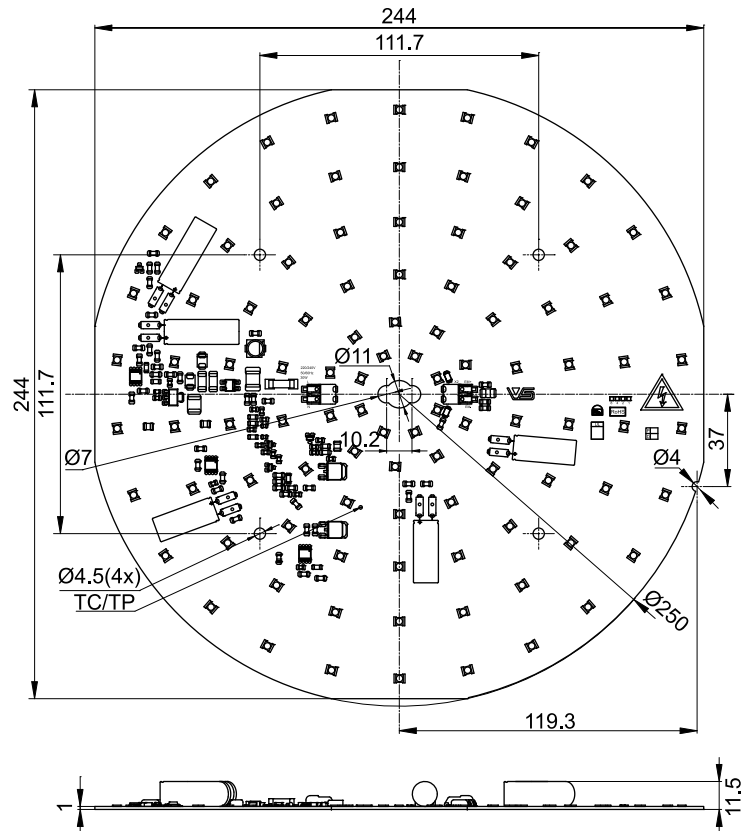

The values contained in this data sheet can change due to technical innovations. Any such changes will be made without separate notification.

LED Modules ReadyLine DL

Mechanical Dimensions

WU-M-540

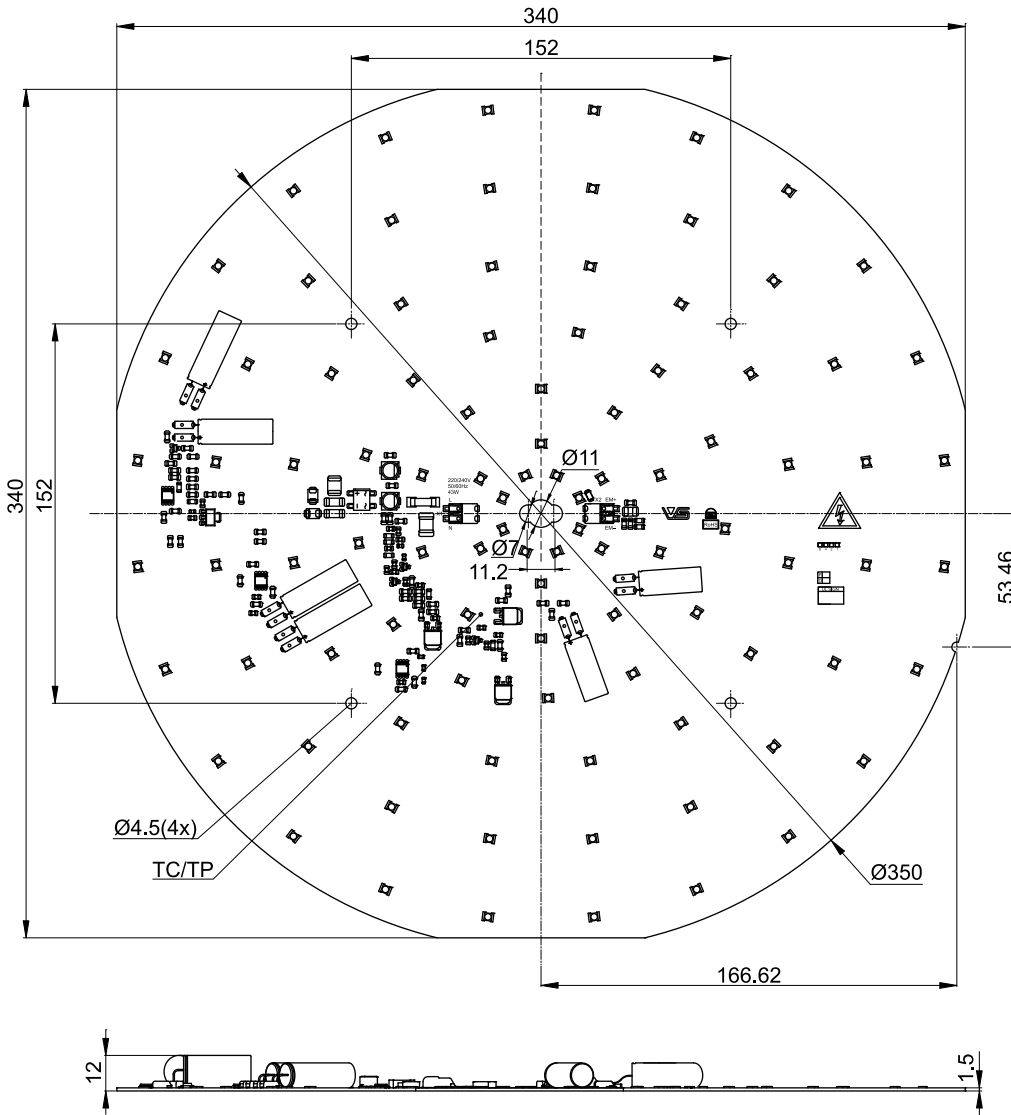

LED Modules ReadyLine DL

Covers for ReadyLine DL modules

Material: PC, transparent or opaque

Max. torque: 1 Nm



Ref. No.	For LED module		Ø A (mm)	Height B (mm)	Mounting distance C (mm)	Max. Ø of PCB D (mm)
	transparent	opaque				
563858	565066	WU-M-538	168.5	21.7	92	158.4
563859	565067	WU-M-539	255.5	22.2	111.7	244.2
563860	565068	WU-M-540	355.5	22.7	152	340.5

Packaging unit: 64 pcs. (WU-M-538) / 22 pcs. (WU-M-539) / 16 pcs. (WU-M-540)

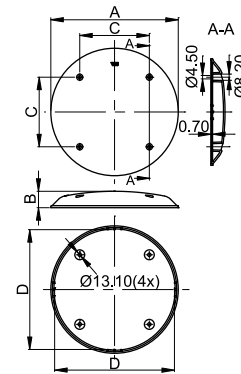

Assembly and Safety Information

The LED modules are designed for direct mains operation (230 V AC). Installation must be carried out under observation country specific relevant safety regulations and standards.

- The LED module is a built-in lighting module to assemble into luminaires.
- Suitable for luminaires of protection class I, grounding is mandatory to comply with safety standards.
- Vossloh-Schwabe recommends to use the cover (Ref. No. 563858, 563859, 563860), in order to comply with applicable safety regulations.
- In case of applications in luminaires of protection class II the safety regulations acc. to luminaire safety standards must be observed.
- Vossloh-Schwabe recommends to use the modules ReadyLine DL EM -Module with VS Emergency Lighting units (Ref. No. 186495, 186498).
- Operation of the LED module is not allowed when it is not built-in into a luminaire. Depending on application, luminaire application specific safety standards have to be observed (e.g. EN 60598 for Europe). Depending on the use of the luminaire in different countries (export), the country specific safety standards have to be regarded (e.g. EN 60598 for Europe).
 - Regard to sufficient isolation acc. country specific standards.
 - Live parts must not be touched. Luminaire must be closed acc. country specific standards.
- Clearance and creepage distances of the module are designed for class I luminaires (basic insulation). For built-in of the module the required standards have to be observed (e.g. EN 60598).
- Do not exceed values given in this specification.
- Do not exceed max t_c temperature of 80 °C.



Danger of life!!!

- The module must be fixed onto a thermally conductive surface. Heat sink must cover the entire backside surface of the module.
- For the operation of WU-M-540 VS recommends to mount the module directly onto the metal heat sink or luminaire housing is mandatory to comply with immunity standards (e.g. EN 61547).
- When installing/screwing the module into a luminaire, please ensure that cables are not squeezed between luminaire/heat-sink and LED module.
- Please ensure standard ESD (electrostatic discharge) protection measures are employed when handling and installing LED modules. Electrostatic discharge can damage LEDs.
- The LED modules are connected via two on board push-in connectors for flexible or solid conductors.
 - Conductor section AWG24-18:
 - Flexible, tinned: 0.25–0.75 mm²
 - Solid: 0.5–0.75 mm²
 - Strip length: 7–9 mm
 - The flexible cable has to be tinned.
 - The contacts can be released with a flat-headed screwdriver with a width of 3 mm. It has to be ensured, that the used cables do not decrease clearance and creepage distance of the modules.
 - The cable must be put in completely (as far as isolation will go) into terminal. Used cables must fulfil luminaire safety standards (EN 60598). Other country specific standards have to be regarded.

The values contained in this data sheet can change due to technical innovations. Any such changes will be made without separate notification.

LED Modules ReadyLine DL

- Parallel connection is mandatory for safe electrical operation. Serial connection of LED modules is not allowed.
- Due to the used electronic parts on the module not all available phase-cutting dimmers are compatible. Dimmable with phase-cutting leading- and trailing-edge dimmer. Minimum dimmer load has to be observed. The compatibility of the dimmer and the modules has to be confirmed prior to installation to avoid flickering.
- To ensure problem-free operation, the specified maximum temperature at the t_c point (see "Operating Life") must be observed (measured in accordance with EN 60598-1). To satisfy this point, it is necessary to put measures in place to ensure any heat is dissipated from the LED module to the environment.
- In the event of outdoor applications or applications in damp locations, care must be taken to protect LED assembly modules against humidity, splashes and jets of water. Any corrosion damage resulting from humidity or contact with condensation will not be recognised as a defect or manufacturing fault. LED assembly modules are not specially protected against foreign bodies or dust. Depending on the type of application, further protection must be ensured to prevent dust and foreign bodies from entering. Relevant country and application specific standards have to be regarded.
- Installation by qualified electrician only
- Do not add or change wires while circuit is active
- Do not make modifications on module
- Do not use adhesives to attach that outgas organic vapour
- Do not use together with material containing sulfur
- Do not operate module with AC generators
- Do not operate modules by DC
- LED modules must not be subjected to any undue mechanical stress, e. g.: LED module
 - handle modules carefully
 - avoid shear and compressive forces onto the modules during handling and installation
 - avoid vibrations of more than 2 kHz, 40 G
- If module is used in rooms with fast moving parts as the light modulation might cause stroboscopic effects.
- This LED module might interfere with displays and cameras due to modulation.
- The photobiological safety of the LED modules is classified into risk groups in accordance with EN 62471: 2008 and IEC TR 62778: risk group 1

Applied Standards

- EN 62031
LED modules for general lighting – Safety specifications



- EN 62471
Photobiological safety of lamps and lamp systems
- EN 55015
Radio disturbance emissions
- EN 61000-3-2
Limits for harmonic emissions
- EN 61547
Immunity requirements

Product Guarantee

- 5 years
- The conditions for the Product Guarantee of the Vossloh-Schwabe Group shall apply as published on our homepage (www.vossloh-schwabe.com). We will be happy to send you these conditions upon request.

The values contained in this data sheet can change due to technical innovations. Any such changes will be made without separate notification.