

ReadyLine COB 57 mm 120 V – For Direct Connection to Mains Voltage

LED MODULES READYLINE COB

BUILT-IN MODULE
57 MM – 120 V



LED MODULES READYLINE COB

EDC_57C_xxW_xxx_120A_VS4

Typical Applications

- Residential lighting
- Replacement for CFL downlights
- Integration in reflector luminaires
- Furniture lighting



LED Modules ReadyLine COB

- **DIRECT MAINS CONNECTION**
- **DIMMABLE**
- **HIGH POWER FACTOR**
- **LONG SERVICE LIFETIME: 50,000 HOURS**
- **UL APPROVED**



LED Modules ReadyLine COB

Technical Notes

- LED built-in module for integration into luminaires
- Mains voltage: 120 V AC
- Power factor: > 0.95
- THD: < 20 %
- Dimensions (ØxH): Ø 57 x 4.7 mm
- On-Board push-in connector
- Light emitting surface (LES)
 - Ø 14 mm: 10 W, 15 W, 20 W
 - Ø 21 mm: 30 W, 40 W

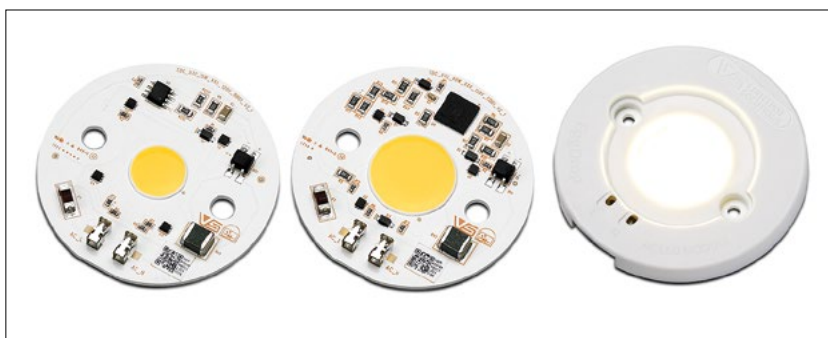

Electrical Characteristics

at $t_c = 55\text{ °C}$

Type	Typ. supply voltage AC V ± 10%	Operation frequency Hz	Typ. power consumption at 120 V W	Power factor	Total harmonic distortion (THD) %	Flicker percent %	Flicker index
EDC_57C_10W_XXX_120A_VS4	120	50-60	10	0.95	< 20	100	0.33
EDC_57C_15W_XXX_120A_VS4	120	50-60	15	0.95	< 20	100	0.33
EDC_57C_20W_XXX_120A_VS4	120	50-60	20	0.95	< 20	100	0.33
EDC_57C_30W_XXX_120A_VS4	120	50-60	30	0.95	< 20	100	0.33
EDC_57C_40W_XXX_120A_VS4	120	50-60	40	0.95	< 20	100	0.33

Maximum Ratings

Exceeding the maximum ratings can lead to reduction of service life or destruction of the modules.

Type	Power consumption W	Operation voltage range AC [V]		Operation temperature range at t_c point		Ambient temperature range		Storage temperature range	
		min.	max.	°C min.	°C max.	°C min.	°C max.	°C min.	°C max.
EDC_57C_xW_XXX_120A_VS4	10, 15, 20	110	130	-30	+70	-30	+50	-30	+85
EDC_57C_30W_XXX_120A_VS4	30	110	130	-30	+70	-30	+40	-30	+85
EDC_57C_40W_XXX_120A_VS4	40	110	130	-30	+70	-30	+35	-30	+85

Operating Life

L70/B50

Temperature at t_c	Service life time
55 °C	50,000 h
70 °C	35,000 h

Typical Light Distribution Curve

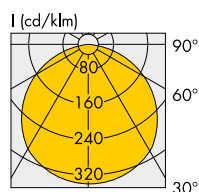

Mechanical Dimensions

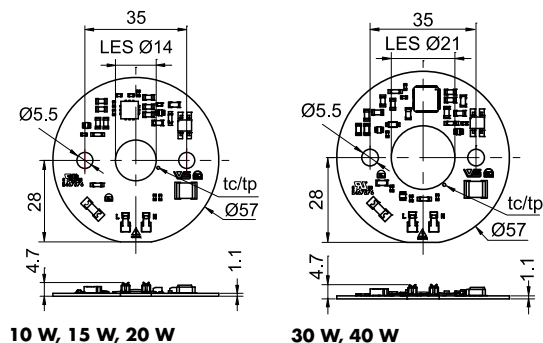

Production Code

EDC_XX X_XXW_X XX_XXX X_VSX					
Type	Shape	Power	CRI	Mains voltage	Version
38 C	4W	8 27	120 A	1	
57 S	6W	9 30	230 D	2	
	8W	35		3	
	10W	40		4	
	15W	50		5	
	20W			6	
	30W				
	40W				

The values contained in this data sheet can change due to technical innovations. Any such changes will be made without separate notification.

LED Modules ReadyLine COB

Optical Characteristics at $t_c1 = 55^\circ\text{C}$, at 120 V AC

Typ. output W	Type	Ref. No.	Colour	Correlated colour temperature* K	Luminous flux (lm) and typ. efficiency (lm/W)**			Typ. beam angle °	Typ. CRI R_a	Energy efficiency
					min. lm	typ. lm	typ. lm/W			
10	EDC_57C_10W827_120A_VS4	564057	warm white	2700	795	884	88	120	80	A+
	EDC_57C_10W830_120A_VS4	564058	warm white	3000	855	950	95	120	80	A+
	EDC_57C_10W835_120A_VS4	564059	warm white	3500	872	969	97	120	80	A+
	EDC_57C_10W840_120A_VS4	564060	neutral white	4000	889	988	99	120	80	A+
	EDC_57C_10W850_120A_VS4	564061	cool white	5000	915	1017	102	120	80	A+
15	EDC_57C_15W827_120A_VS4	564067	warm white	2700	1193	1325	88	120	80	A+
	EDC_57C_15W830_120A_VS4	564068	warm white	3000	1283	1425	95	120	80	A+
	EDC_57C_15W835_120A_VS4	564069	warm white	3500	1308	1454	97	120	80	A+
	EDC_57C_15W840_120A_VS4	564070	neutral white	4000	1334	1482	99	120	80	A+
	EDC_57C_15W850_120A_VS4	564071	cool white	5000	1372	1525	102	120	80	A+
20	EDC_57C_20W827_120A_VS4	564077	warm white	2700	1590	1767	88	120	80	A+
	EDC_57C_20W830_120A_VS4	564078	warm white	3000	1710	1900	95	120	80	A+
	EDC_57C_20W835_120A_VS4	564079	warm white	3500	1744	1938	97	120	80	A+
	EDC_57C_20W840_120A_VS4	564080	neutral white	4000	1778	1976	99	120	80	A+
	EDC_57C_20W850_120A_VS4	564081	cool white	5000	1830	2033	102	120	80	A+
30	EDC_57C_30W827_120A_VS4	564087	warm white	2700	2314	2571	86	120	80	A+
	EDC_57C_30W830_120A_VS4	564088	warm white	3000	2488	2765	92	120	80	A+
	EDC_57C_30W835_120A_VS4	564089	warm white	3500	2538	2820	94	120	80	A+
	EDC_57C_30W840_120A_VS4	564090	neutral white	4000	2588	2875	96	120	80	A+
	EDC_57C_30W850_120A_VS4	564091	cold white	5000	2662	2958	99	120	80	A+
40	EDC_57C_40W827_120A_VS4	564097	warm white	2700	2958	3287	82	120	80	A+
	EDC_57C_40W830_120A_VS4	564098	warm white	3000	3181	3534	88	120	80	A+
	EDC_57C_40W835_120A_VS4	564099	warm white	3500	3244	3605	90	120	80	A+
	EDC_57C_40W840_120A_VS4	564100	neutral white	4000	3308	3675	92	120	80	A+
	EDC_57C_40W850_120A_VS4	564101	cold white	5000	3403	3781	95	120	80	A+

* Colour tolerance: 3 MacAdam | ** Production tolerance of luminous flux and efficiency: $\pm 10\%$ | CRI ± 3

Minimum order quantity: 100 pcs.

The values contained in this data sheet can change due to technical innovations. Any such changes will be made without separate notification.

LED Modules ReadyLine COB – HiCRI

Optical Characteristics at $t_c1 = 55^\circ\text{C}$, at 120 V AC

Typ. output W	Type	Ref. No.	Colour	Correlated colour temperature* K	Luminous flux (lm) and typ. efficiency (lm/W)**			Typ. beam angle °	Typ. CRI R_a	Energy efficiency
					min. lm	typ. lm	typ. lm/W			
10	EDC_57C_10W927_120A_VS4	564062	warm white	2700	700	777	78	120	90	A+
	EDC_57C_10W930_120A_VS4	564063	warm white	3000	752	836	84	120	90	A+
	EDC_57C_10W935_120A_VS4	564064	warm white	3500	767	853	85	120	90	A+
	EDC_57C_10W940_120A_VS4	564065	neutral white	4000	782	869	87	120	90	A+
	EDC_57C_10W950_120A_VS4	564066	cool white	5000	805	895	89	120	90	A+
15	EDC_57C_15W927_120A_VS4	564072	warm white	2700	1050	1166	78	120	90	A
	EDC_57C_15W930_120A_VS4	564073	warm white	3000	1129	1254	84	120	90	A+
	EDC_57C_15W935_120A_VS4	564074	warm white	3500	1151	1279	85	120	90	A+
	EDC_57C_15W940_120A_VS4	564075	neutral white	4000	1174	1304	87	120	90	A+
	EDC_57C_15W950_120A_VS4	564076	cool white	5000	1208	1342	89	120	90	A+
20	EDC_57C_20W927_120A_VS4	564082	warm white	2700	1399	1555	78	120	90	A
	EDC_57C_20W930_120A_VS4	564083	warm white	3000	1505	1672	84	120	90	A
	EDC_57C_20W935_120A_VS4	564084	warm white	3500	1535	1705	85	120	90	A+
	EDC_57C_20W940_120A_VS4	564085	neutral white	4000	1565	1739	87	120	90	A+
	EDC_57C_20W950_120A_VS4	564086	cool white	5000	1610	1789	89	120	90	A+
30	EDC_57C_30W927_120A_VS4	564092	warm white	2700	2036	2262	75	120	90	A
	EDC_57C_30W930_120A_VS4	564093	warm white	3000	2189	2433	81	120	90	A
	EDC_57C_30W935_120A_VS4	564094	warm white	3500	2233	2481	83	120	90	A+
	EDC_57C_30W940_120A_VS4	564095	neutral white	4000	2277	2530	84	120	90	A+
	EDC_57C_30W950_120A_VS4	564096	cool white	5000	2343	2603	87	120	90	A+
40	EDC_57C_40W927_120A_VS4	564102	warm white	2700	2609	2892	72	120	90	A
	EDC_57C_40W930_120A_VS4	564103	warm white	3000	2799	3110	78	120	90	A
	EDC_57C_40W935_120A_VS4	564104	warm white	3500	2855	3172	79	120	90	A+
	EDC_57C_40W940_120A_VS4	564105	neutral white	4000	2911	3234	81	120	90	A+
	EDC_57C_40W950_120A_VS4	564106	cool white	5000	2995	3328	83	120	90	A+

* Colour tolerance: 3 MacAdam | ** Production tolerance of luminous flux and efficiency: $\pm 10\%$ | CRI ± 3

Minimum order quantity: 100 pcs.

The values contained in this data sheet can change due to technical innovations. Any such changes will be made without separate notification.

Accessories for LED Modules ReadyLine COB



Holder

Dimensions (ØxH): 59.8x6.6 mm

Material: plastic, white

Ref. No.: 559786

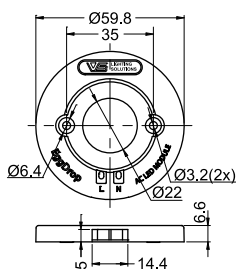

Holder for EVO reflectors

For COB Type EDC57C

Cover for LES: PC, transparent

Dimensions (ØxH): 60 x14.65 mm

Packaging unit: 72 pcs

Ref. No.: 561847 Material: PC, black
inner ring: metallized

Ref. No.: 563095 Material: PC, white

Ref. No.: 568892 Material: PC, natural (5 VA)

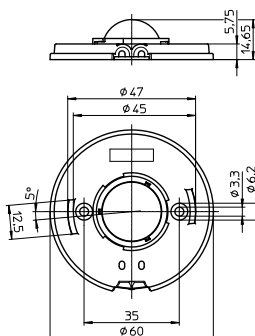

Thermal Pad

Dimensions (ØxH): 63x0.5 mm

Thermal conductivity λ :

2 W/mK (10 W, 15 W, 20 W, 30 W)

5 W/mK (40 W)

Ref. No.: 559883

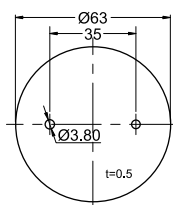

The values contained in this data sheet can change due to technical innovations. Any such changes will be made without separate notification.

Accessories for LED Modules ReadyLine COB

Exchangeable aluminum reflectors

Technical notes

Reflectors made of aluminium with bayonet fixation

Surface: anodised

Weight: 27/17 g (D90/D75)

Packaging unit: 18 pcs.

Usage and maintenance

If necessary clean reflectors with mild soap, water and soft cloth.

Never use any commercial cleaning solvents on reflectors, like alcohol.

Please handle or install reflectors with wearing gloves, skin oils may damage reflector or its optical characteristic.

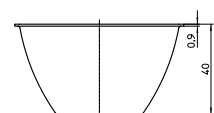
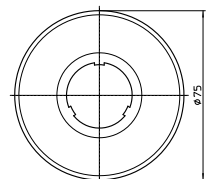
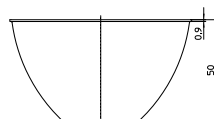
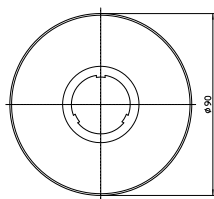

Ref. No.	Beam characteristic	Beam angle (°)	
		EDC_57C_10W / 15W / 20W LES Ø 14 mm	EDC_57C_30W / 40W LES Ø 21 mm

Reflector D90 – H = 50

557359	narrow	14	20
557360	medium	24	28
557361	wide	26	36
563446	extra wide	45	50

Reflector D75 – H = 40

557152	narrow	14	20
557153	medium	24	25
557154	wide	32	40
562157	extra wide	50	62



It's possible to use all the reflectors on the same holder.

The values contained in this data sheet can change due to technical innovations. Any such changes will be made without separate notification.

LED Modules ReadyLine COB

Assembly and Safety Information

The LED modules are designed for direct mains operation (120 V AC). Installation must be carried out under observation country specific relevant safety regulations and standards.

- The LED module is a built-in lighting module to assemble into luminaires. 
- Suitable for luminaires of protection class I, grounding is mandatory to comply with safety standards.
- When using the 30 W and 40 W version, the thermal pad (Ref. No. 559883) and the holder (Ref. No. 559786) are mandatory to comply with applicable safety regulations.
- In case of applications in luminaires of protection class II the safety regulations acc. to luminaire safety standards must be observed.
- Operation of the LED module is not allowed when it is not built-in into a luminaire. Depending on application, luminaire application specific safety standards have to be observed (e.g. UL 8750). Depending on the use of the luminaire in different countries (export), the country specific safety standards have to be regarded (e.g. UL 8750).
 - Regard to sufficient isolation acc. country specific standards.
 - Live parts must not be touched. Luminaire must be closed acc. country specific standards. Danger of life!!! 
- Clearance and creepage distances of the module are designed for class I luminaires (basic insulation). For built-in of the module the required standards have to be observed (e.g. UL 8750).
- Do not exceed values given in this specification.
- Do not exceed max t_c temperature of 85 °C.
- The module must be fixed onto a thermally conductive surface. Heat sink must cover the entire backside surface of the module.
- When installing/screwing the module into a luminaire, please ensure that cables are not squeezed between luminaire/heat-sink and LED module.
- Please ensure standard ESD (electrostatic discharge) protection measures are employed when handling and installing LED modules. Electrostatic discharge can damage LEDs.
- The LED modules are connected via two on board push-in connectors for flexible or solid conductors.
 - Conductor section: AWG22-AWG18
 - Flexible: 0.45 mm² – 0.96 mm²
 - Solid: 0.324 mm² – 0.82 mm²
 - Strip length: 6 mm ±0.5 mm
 - The AWG22 flexible cable has to be tinned
 - The AWG20 and AWG18 wires have to be twisted.
 - The contacts can be released with a flat-headed screwdriver with a width of 3 mm. It has to be ensured, that the used cables do not decrease clearance and creepage distance of the modules.
 - The cable must be put in completely (as far as isolation will go) into terminal. Used cables must fulfil luminaire safety standards (UL 8750). Other country specific standards have to be regarded.
- Parallel connection is mandatory for safe electrical operation. Serial connection of LED modules is not allowed.

- Due to the used electronic parts on the module not all available phase-cutting dimmers are compatible. Dimmable with phase-cutting leading- and trailing-edge dimmer. Minimum dimmer load has to be observed. The compatibility of the dimmer and the modules has to be confirmed prior to installation to avoid flickering.
- The modules must be fixed with M4 screws. Fixation only with flat or cylinder head screws (M4) (no countersank screws). Max. torque for PCB: 0.6 Nm (M4), max. torque with holder: 0.3 Nm (M4).
- To ensure problem-free operation, the specified maximum temperature at the t_c point (see "Operating Life") must be observed. To satisfy this point, it is necessary to put measures in place to ensure any heat is dissipated from the LED module to the environment.
- In the event of outdoor applications or applications in damp locations, care must be taken to protect LED assembly modules against humidity, splashes and jets of water. Any corrosion damage resulting from humidity or contact with condensation will not be recognised as a defect or manufacturing fault. LED assembly modules are not specially protected against foreign bodies or dust. Depending on the type of application, further protection must be ensured to prevent dust and foreign bodies from entering. Relevant country and application specific standards have to be regarded.
- Installation by qualified electrician only
- Do not add or change wires while circuit is active
- Do not make modifications on module
- Do not use adhesives to attach that outgas organic vapour
- Do not use together with material containing sulfur
- Do not operate module with AC generators
- Do not operate modules by DC
- LED modules must not be subjected to any undue mechanical stress, e. g.: LED module
 - handle modules carefully
 - avoid shear and compressive forces onto the modules during handling and installation
 - avoid vibrations of more than 2 kHz, 40 G
- If module is used in rooms with fast moving parts as the light modulation might cause stroboscopic effects.
- This LED module might interfere with displays and cameras due to modulation.

Applied Standards

- UL 8750
Standard for LED Equipment for Use in Lighting Products

Product Guarantee

- 5 years
- The conditions for the Product Guarantee of the Vossloh-Schwabe Group shall apply as published on our homepage (www.vossloh-schwabe.com). We will be happy to send you these conditions upon request.

The values contained in this data sheet can change due to technical innovations. Any such changes will be made without separate notification.

Tested dimmers for LED Modules ReadyLine COB

ReadyLine COB modules are dimmable with common phase-cut dimmers.

Minimum dimmer load has to be observed.

The compatibility of the dimmer and the modules has to be approved prior to installation.

- ASPIRE COOPER
- LUTRON DIVA. DVCL153P-WH
- SKYLARK SELV-300P
- SKYLARK SLV-600P
- LUTRON MIR-600
- LUTRON MIR-600M-WH
- LUTRON DIVA. DV-600P
- LUTRON ARIADNI. AW-600P-WH
- LUTRON SKYLARK. S-600P-WH
- LUTRON NOVA T. NTLV-600
- LUTRON TG-600P-WH
- LEVITON IPI 10-1 LZ
- LUTRON GL-6000H-DK
- LEVITON NO. 6683-T
- LEVITON NO. 6602
- LEVITON NO. 6681
- LEVITON NO. 6631-LA
- STEPUP COOPER
- ARROWHART COOPER. SF10P-W
- JASCO PRODUCTS XOOOPKSTEP
- LUTRON NOVA T. NT 1000
- LUTRON DIVA. DVTV-WH
- LUTRON MAESTRO. MA-600-WH
- LEVITON IP710-DL
- LEVITON IPE04
- LEVITON NO. 6674
- LUTRON SKYLARK. CT-600P
- LEVITON 1G4411
- LEVITON 1D4405
- LUTRON GL X52-F04160

The values contained in this data sheet can change due to technical innovations. Any such changes will be made without separate notification.