

LED LINE SMD GEN. 5 L14/28/56 W2

700 lm, 1400 lm, 2100 lm



LED LINE SMD GEN. 5 L14/28/56 W2

– 700 lm, 1400 lm, 2100 lm

WU-M-654/655/656

WU-M-657/658/659

WU-M-660/661/662

Typical Applications

Built-in luminaires/general illumination

- Office lighting
- Retail, corridor and shelf lighting
- T5/T8 replacement as built-in module
- Furniture lighting
- Backlighting for advertising

LED Line SMD Gen. 5 – L14/28/56 W2

■ **LONG SERVICE LIFE TIME: 78,000 H (L80, B10)**

■ **HIGHLY EFFICIENT: UP TO 211 LM/W
AT T_p = 50 °C**

■ **3 LENGTHS AVAILABLE:
140 / 280 / 560 MM**

■ **3 DIFFERENT LUMEN PACKAGES**



LED Line SMD Gen. 5 – L14/28/56 W2

Technical Notes

- LED built-in module for integration into luminaires
- Dimensions
WU-M-654/655/656: 140x20 mm
WU-M-657/658/659: 280x20 mm
WU-M-660/661/662: 560x20 mm
- Driving current: 150 mA / 250 mA / 350 mA / 500 mA
- On-board push-in terminals, optional on top or bottom
- Beam angle: 120°

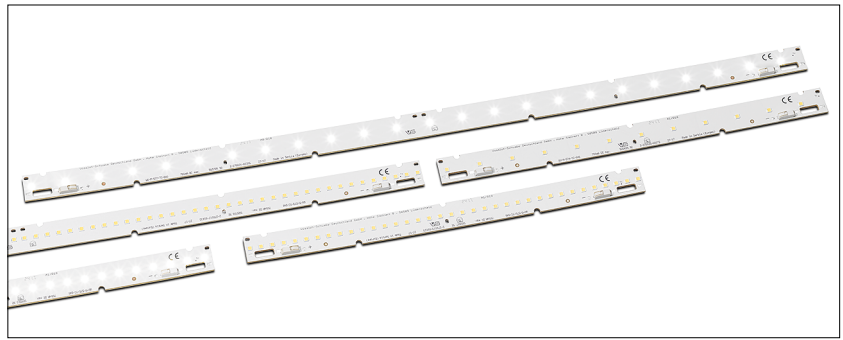

Typical Light Distribution Curve

Data are available in .ldt format for download under www.vossloh-schwabe.com.

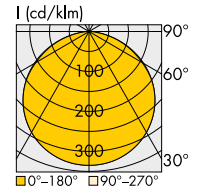

Covers and W2 optics

Please visit our homepage for details for suitable covers and W2 optics:

- www.vossloh-schwabe.com/en/products/optics-reflectors/linear-covers/linear-covers-1r-for-led-line-smd-w2-pcb/
- www.vossloh-schwabe.com/en/products/optics-reflectors/linear-optics/linear-optics-1r-for-led-line-smd-w2-pcb/

Electrical Characteristics

at $t_p = 50\text{ °C}$

Type	No. of SMDs	Typ. voltage DC				Temperature coefficient mV/K	Typ. power consumption			
		150 mA V	250 mA V	350 mA V	500 mA V		150 mA W	250 mA W	350 mA W	500 mA W
LED Line SMD Gen. 5 – L14 W2										
WU-M-654	6	5.3	5.4	5.4	5.5	-2.46	0.8	1.3	1.9	2.8
WU-M-655	12	10.6	10.7	10.8	11.0	-4.93	1.6	2.7	3.8	5.5
WU-M-656	18	15.9	16.1	16.3	16.5	-7.39	2.4	4.0	5.7	8.3
LED Line SMD Gen. 5 – L28 W2										
WU-M-657	12	10.6	10.7	10.8	11.0	-4.93	1.6	2.7	3.8	5.5
WU-M-658	24	21.1	21.4	21.7	22.0	-9.85	3.2	5.4	7.6	11.0
WU-M-659	36	31.7	32.2	32.5	33.0	-14.78	4.8	8.0	11.4	16.5
LED Line SMD Gen. 5 – L56 W2										
WU-M-660	24	21.1	21.4	21.7	22.0	-9.85	3.2	5.4	7.6	11.0
WU-M-661	48	42.3	42.9	43.4	44.1	-19.71	6.3	10.7	15.2	22.0
WU-M-662	72	63.4	64.3	65.1	66.1	-29.56	9.5	16.1	22.8	33.0

Voltage and power consumption tolerance: $\pm 10\%$

Use of external LED constant current driver required.

Maximum Ratings

Exceeding the maximum ratings can lead to reduction of service life or destruction of the module.

Type	Operating current (mA)	Operation temperature range at t_c point		Storage temperature range		Max. allowed repetitive peak current for frequencies ≥ 100 Hz in mA
		$^{\circ}\text{C}$ min.	$^{\circ}\text{C}$ max.	$^{\circ}\text{C}$ min.	$^{\circ}\text{C}$ max.	
All types	500	-20	+80	-20	+70	600

Operating Life

L80/B10

in hours at measured temperature at t_p point

Type	150 mA			250 mA			350 mA			500 mA		
	40 $^{\circ}\text{C}$	50 $^{\circ}\text{C}$	80 $^{\circ}\text{C}$	40 $^{\circ}\text{C}$	50 $^{\circ}\text{C}$	80 $^{\circ}\text{C}$	40 $^{\circ}\text{C}$	50 $^{\circ}\text{C}$	80 $^{\circ}\text{C}$	40 $^{\circ}\text{C}$	50 $^{\circ}\text{C}$	80 $^{\circ}\text{C}$
All types	> 78,000	> 78,000	> 78,000	> 78,000	> 78,000	> 78,000	> 78,000	> 78,000	> 78,000	> 72,000	> 72,000	> 72,000

The values contained in this data sheet can change due to technical innovations. Any such changes will be made without separate notification.

LED Line SMD Gen. 5 – L14/28/56 W2

Optical Characteristics

at $T_p = 50\text{ °C}$

CRI: $R_a > 80$

Type	Ref. No. Connection			Colour	Correlated colour temperature* K	Typ. luminous flux** and typ. efficiency** at								Photo-metric code
	top (TC)	bottom (BC)	small top (STC)			150 mA		250 mA		350 mA		500 mA		
						lm	lm/W	lm	lm/W	lm	lm/W	lm	lm/W	
LED Line SMD Gen. 5 – L14 W2														
WU-M--654-TC/BC/STC-830	570593	on request	on request	warm white	3000	155	198	260	193	355	188	500	182	830/349
WU-M--654-TC/BC/STC-840	570594	on request	on request	neutral white	4000	165	210	275	205	380	200	530	193	840/349
WU-M--654-TC/BC/STC-850	570595	on request	on request	cool white	5000	165	211	275	206	380	201	535	194	850/349
WU-M--654-TC/BC/STC-865	570596	on request	571486	cool white	6500	155	198	260	193	360	189	500	182	865/349
WU-M--655-TC/BC/STC-830	570597	on request	572776	warm white	3000	315	198	515	193	715	188	1000	182	830/349
WU-M--655-TC/BC/STC-840	570598	on request	572777	neutral white	4000	335	210	550	205	760	200	1065	193	840/349
WU-M--655-TC/BC/STC-850	570599	on request	on request	cool white	5000	335	211	550	206	765	201	1070	194	850/349
WU-M--655-TC/BC/STC-865	570600	on request	on request	cool white	6500	315	198	520	193	715	189	1005	182	865/349
WU-M--656-TC/BC/STC-830	570601	571487	on request	warm white	3000	470	198	775	193	1070	188	1500	182	830/349
WU-M--656-TC/BC/STC-840	570602	on request	on request	neutral white	4000	500	210	825	205	1140	200	1595	193	840/349
WU-M--656-TC/BC/STC-850	on request	on request	on request	cool white	5000	500	211	830	206	1145	201	1605	194	850/349
WU-M--656-TC/BC/STC-865	on request	on request	on request	cool white	6500	470	198	775	193	1075	189	1505	182	865/349
LED Line SMD Gen. 5 – L28 W2														
WU-M--657-TC/BC/STC-830	570603	570607	570611	warm white	3000	315	198	515	193	715	188	1000	182	830/349
WU-M--657-TC/BC/STC-840	570604	570608	570612	neutral white	4000	335	210	550	205	760	200	1065	193	840/349
WU-M--657-TC/BC/STC-850	570605	570609	on request	cool white	5000	335	211	550	206	765	201	1070	194	850/349
WU-M--657-TC/BC/STC-865	570606	570610	on request	cool white	6500	315	198	520	193	715	189	1005	182	865/349
WU-M--658-TC/BC/STC-830	570618	570622	570626	warm white	3000	625	198	1035	193	1430	188	2000	182	830/349
WU-M--658-TC/BC/STC-840	570619	570623	570627	neutral white	4000	665	210	1100	205	1520	200	2125	193	840/349
WU-M--658-TC/BC/STC-850	570620	570624	on request	cool white	5000	670	211	1105	206	1530	201	2135	194	850/349
WU-M--658-TC/BC/STC-865	570621	570625	on request	cool white	6500	630	198	1035	193	1435	189	2005	182	865/349
WU-M--659-TC/BC/STC-830	570636	on request	on request	warm white	3000	940	198	1550	193	2145	188	3000	182	830/349
WU-M--659-TC/BC/STC-840	570637	570638	on request	neutral white	4000	1000	210	1650	205	2280	200	3190	193	840/349
WU-M--659-TC/BC/STC-850	on request	on request	on request	cool white	5000	1005	211	1655	206	2290	201	3205	194	850/349
WU-M--659-TC/BC/STC-865	on request	on request	on request	cool white	6500	940	198	1555	193	2150	189	3010	182	865/349
LED Line SMD Gen. 5 – L56 W2														
WU-M--660-TC/BC/STC-830	570641	570645	570653	warm white	3000	625	198	1035	193	1430	188	2000	182	830/349
WU-M--660-TC/BC/STC-840	570642	570646	570654	neutral white	4000	665	210	1100	205	1520	200	2125	193	840/349
WU-M--660-TC/BC/STC-850	570643	570647	on request	cool white	5000	670	211	1105	206	1530	201	2135	194	850/349
WU-M--660-TC/BC/STC-865	570644	570648	on request	cool white	6500	630	198	1035	193	1435	189	2005	182	865/349
WU-M--661-TC/BC/STC-830	570655	570659	570663	warm white	3000	1255	198	2070	193	2860	188	4000	182	830/349
WU-M--661-TC/BC/STC-840	570656	570660	570664	neutral white	4000	1330	210	2200	205	3040	200	4255	193	840/349
WU-M--661-TC/BC/STC-850	570657	570661	on request	cool white	5000	1340	211	2210	206	3055	201	4275	194	850/349
WU-M--661-TC/BC/STC-865	570658	570662	on request	cool white	6500	1255	198	2075	193	2865	189	4010	182	865/349
WU-M--662-TC/BC/STC-830	570673	on request	on request	warm white	3000	1880	198	3100	193	4290	188	6000	182	830/349
WU-M--662-TC/BC/STC-840	570674	570675	on request	neutral white	4000	2000	210	3300	205	4560	200	6380	193	840/349
WU-M--662-TC/BC/STC-850	573196	on request	on request	cool white	5000	2010	211	3315	206	4585	201	6410	194	850/349
WU-M--662-TC/BC/STC-865	573197	573100	on request	cool white	6500	1885	198	3110	193	4300	189	6015	182	865/349

* Colour tolerance: 3 MacAdam | ** Production tolerance of luminous flux and efficiency: $\pm 10\%$
Minimum order quantity (packaging unit): 48 pcs. for L14 / 24 pcs. for L28 and L56

The values contained in this data sheet can change due to technical innovations. Any such changes will be made without separate notification.

LED Line SMD Gen. 5 – L14/28/56 W2

Optical Characteristics

at $T_p = 50\text{ °C}$

CRI: $R_a > 90$

Type	Ref. No. Connection			Colour	Correlated colour temperature* K	Typ. luminous flux** and typ. efficiency** at								Photo-metric code
	top (TC)	bottom (BC)	small top (STC)			150 mA		250 mA		350 mA		500 mA		
						lm	lm/W	lm	lm/W	lm	lm/W	lm	lm/W	
LED Line SMD Gen. 5 – L14 W2														
WU-M--654-TC/BC/STC-930	on request	on request	on request	warm white	3000	125	156	205	152	280	148	395	143	930/349
WU-M--654-TC/BC/STC-940	on request	on request	on request	neutral white	4000	130	162	210	158	295	155	410	149	940/349
WU-M--654-TC/BC/STC-950	on request	on request	on request	cool white	5000	130	165	215	160	295	157	415	151	950/349
WU-M--654-TC/BC/STC-965	on request	on request	on request	cool white	6500	125	157	205	153	285	149	395	144	965/349
WU-M--655-TC/BC/STC-930	on request	on request	on request	warm white	3000	245	156	405	152	565	148	790	143	930/349
WU-M--655-TC/BC/STC-940	on request	on request	on request	neutral white	4000	255	162	425	158	585	155	820	149	940/349
WU-M--655-TC/BC/STC-950	on request	on request	on request	cool white	5000	260	164	430	160	595	157	830	151	950/349
WU-M--655-TC/BC/STC-965	on request	on request	on request	cool white	6500	250	157	410	153	565	149	795	144	965/349
WU-M--656-TC/BC/STC-930	on request	on request	on request	warm white	3000	370	156	610	152	845	148	1180	143	930/349
WU-M--656-TC/BC/STC-940	on request	on request	on request	neutral white	4000	385	162	635	158	880	155	1230	149	940/349
WU-M--656-TC/BC/STC-950	on request	on request	on request	cool white	5000	390	164	645	160	890	157	1250	151	950/349
WU-M--656-TC/BC/STC-965	on request	on request	on request	cool white	6500	375	157	615	153	850	149	1190	144	965/349
LED Line SMD Gen. 5 – L28 W2														
WU-M--657-TC/BC/STC-930	570613	on request	on request	warm white	3000	245	156	405	152	565	148	790	143	930/349
WU-M--657-TC/BC/STC-940	570614	570617	on request	neutral white	4000	255	162	425	158	585	155	820	149	940/349
WU-M--657-TC/BC/STC-950	570615	on request	on request	cool white	5000	260	164	430	160	595	157	830	151	950/349
WU-M--657-TC/BC/STC-965	570616	on request	on request	cool white	6500	250	157	410	153	565	149	795	144	965/349
WU-M--658-TC/BC/STC-930	570628	570632	570634	warm white	3000	495	156	815	152	1125	148	1575	143	930/349
WU-M--658-TC/BC/STC-940	570629	570633	570635	neutral white	4000	515	162	850	158	1175	155	1640	149	940/349
WU-M--658-TC/BC/STC-950	570630	on request	on request	cool white	5000	520	164	860	160	1190	157	1665	151	950/349
WU-M--658-TC/BC/STC-965	570631	on request	on request	cool white	6500	495	157	820	153	1135	149	1585	144	965/349
WU-M--659-TC/BC/STC-930	on request	on request	on request	warm white	3000	740	156	1220	152	1690	148	2365	143	930/349
WU-M--659-TC/BC/STC-940	570639	570640	on request	neutral white	4000	770	162	1275	158	1760	155	2460	149	940/349
WU-M--659-TC/BC/STC-950	on request	on request	on request	cool white	5000	780	164	1290	160	1785	157	2495	151	950/349
WU-M--659-TC/BC/STC-965	on request	on request	on request	cool white	6500	745	157	1230	153	1700	149	2380	144	965/349
LED Line SMD Gen. 5 – L56 W2														
WU-M--660-TC/BC/STC-930	570649	on request	on request	warm white	3000	495	156	815	152	1125	148	1575	143	930/349
WU-M--660-TC/BC/STC-940	570650	on request	on request	neutral white	4000	515	162	850	158	1175	155	1640	149	940/349
WU-M--660-TC/BC/STC-950	570651	on request	on request	cool white	5000	520	164	860	160	1190	157	1665	151	950/349
WU-M--660-TC/BC/STC-965	570652	on request	on request	cool white	6500	495	157	820	153	1135	149	1585	144	965/349
WU-M--661-TC/BC/STC-930	570665	570669	570671	warm white	3000	985	156	1630	152	2250	148	3150	143	930/349
WU-M--661-TC/BC/STC-940	570666	570670	570672	neutral white	4000	1030	162	1695	158	2345	155	3285	149	940/349
WU-M--661-TC/BC/STC-950	570667	on request	on request	cool white	5000	1040	164	1720	160	2380	157	3325	151	950/349
WU-M--661-TC/BC/STC-965	570668	on request	on request	cool white	6500	995	157	1640	153	2270	149	3175	144	965/349
WU-M--662-TC/BC/STC-930	on request	on request	on request	warm white	3000	1480	156	2445	152	3380	148	4725	143	930/349
WU-M--662-TC/BC/STC-940	570676	on request	on request	neutral white	4000	1545	162	2545	158	3520	155	4925	149	940/349
WU-M--662-TC/BC/STC-950	on request	on request	on request	cool white	5000	1565	164	2580	160	3570	157	4990	151	950/349
WU-M--662-TC/BC/STC-965	on request	on request	on request	cool white	6500	1490	157	2460	153	3400	149	4760	144	965/349

* Colour tolerance: 3 MacAdam | ** Production tolerance of luminous flux and efficiency: $\pm 10\%$
Minimum order quantity (packaging unit): 48 pcs. for L14 / 24 pcs. for L28 and L56

The values contained in this data sheet can change due to technical innovations. Any such changes will be made without separate notification.

Mechanical Dimensions

TC = Top Connection
BC = Bottom Connection
STC = Small Top Connection

WU-M-654 BC/TC

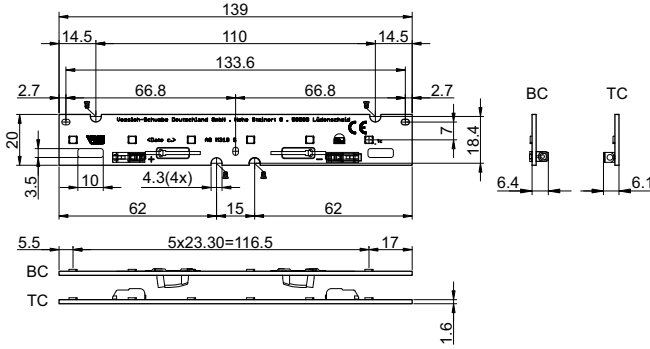

WU-M-654 STC

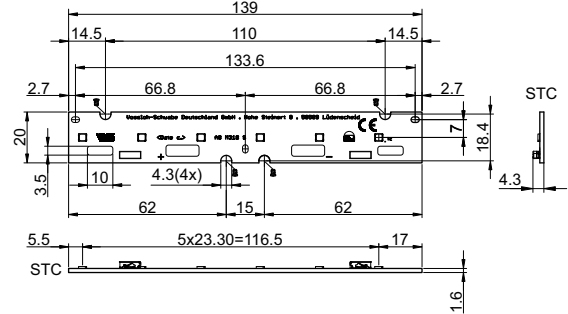

WU-M-655 BC/TC

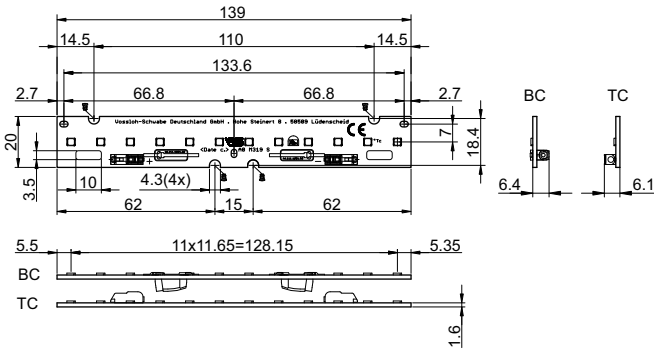

WU-M-655 STC

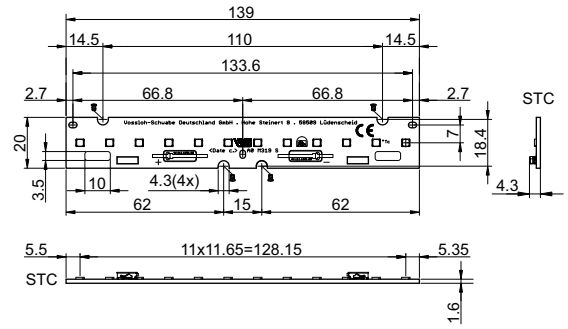

WU-M-656 BC/TC

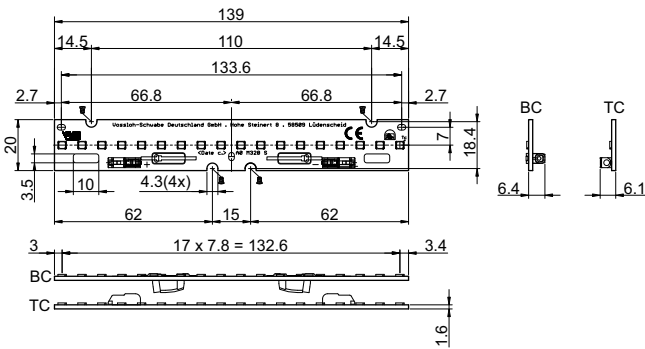

WU-M-656 STC

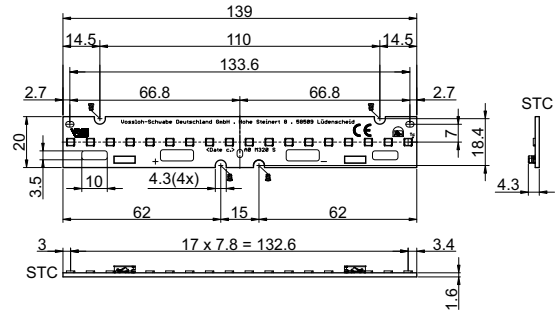

The values contained in this data sheet can change due to technical innovations. Any such changes will be made without separate notification.

Mechanical Dimensions

TC = Top Connection
BC = Bottom Connection
STC = Small Top Connection

WU-M-657 BC/TC

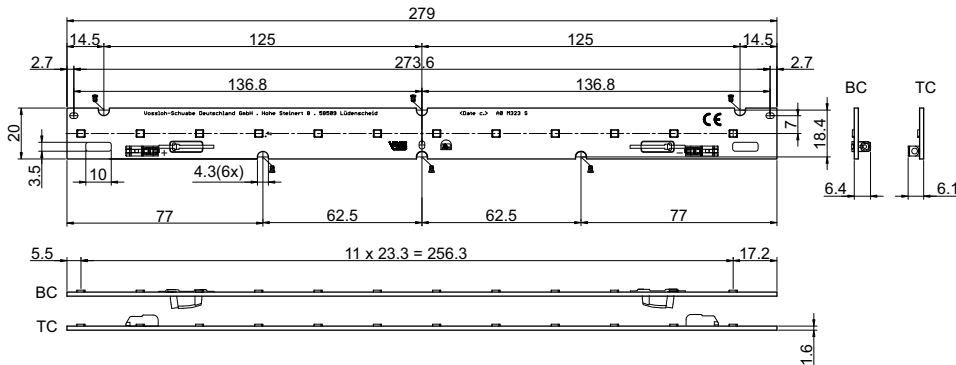

WU-M-657 STC

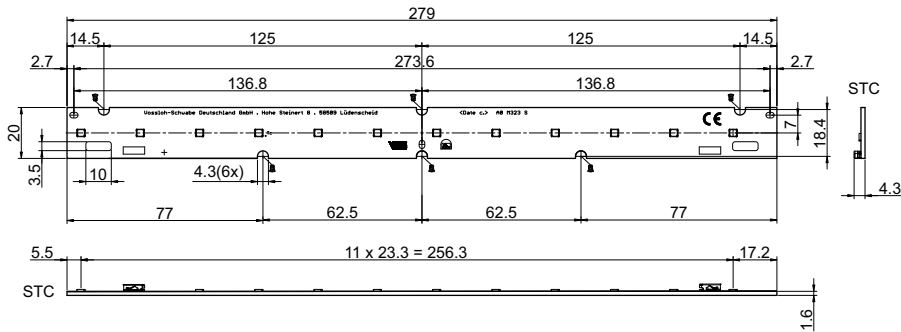

WU-M-658 BC/TC

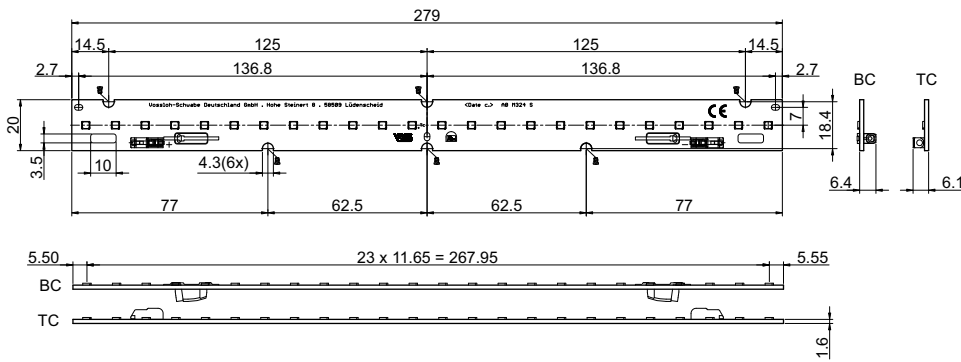

WU-M-658 STC

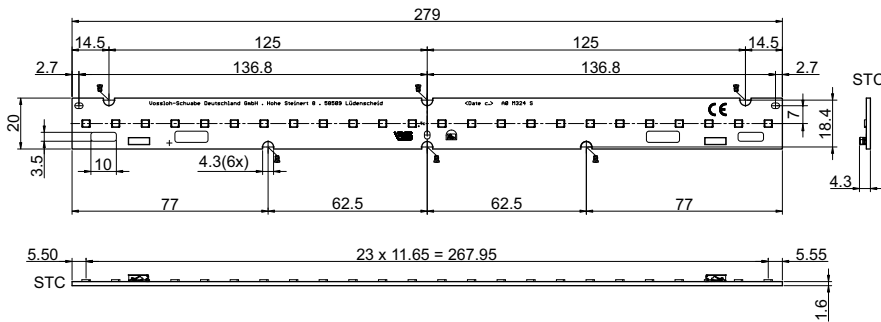

The values contained in this data sheet can change due to technical innovations. Any such changes will be made without separate notification.

Connection Example

- The number of modules that can be connected in series depends on the available output voltage of the LED driver.
- The clearance and creepage distances are designed for working voltages up to 350 V DC (basic insulation) and 185 V DC (reinforced insulation).
- In case of assembly of the LED modules in profiles (e.g. aluminium) where the profile touches the top edge of the PCB the clearance and creepage distances are reduced to 175 V DC (basic insulation) and 50 V DC (reinforced insulation).
- Max. diameter of screw head (M4): \varnothing 8 mm
- Only the marked holes  are fixing holes for screws M4. Please do not use other holes for fixation!

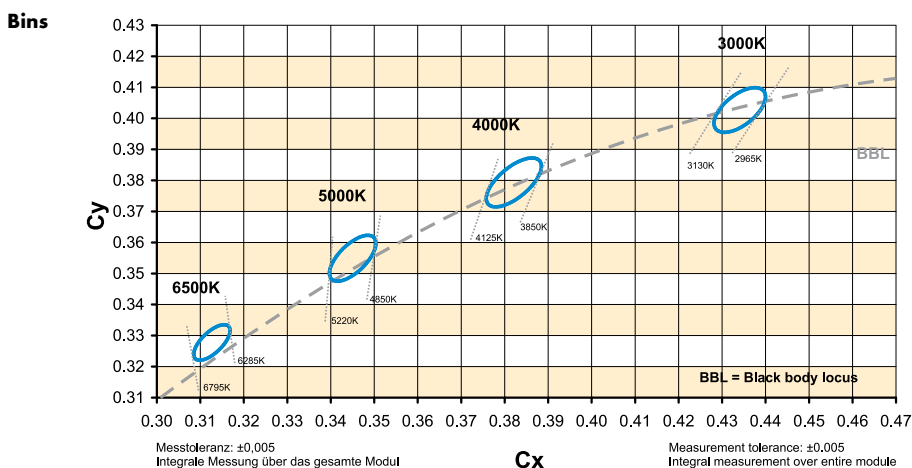
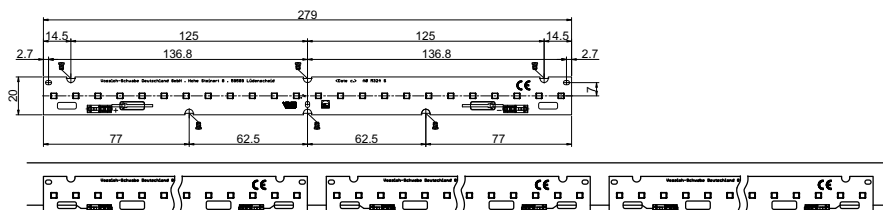

Fixing clips for LED PCBs

For screwless fastening of LED PCB to the luminaire sheet
The clamping range (MT) is a sum of PCB thickness (PCB)
+ luminaire sheet thickness (Metal sheet).

Material: PC, white (UL-94 V-2)

For PCB fixing hole diameter:

\varnothing 4.1–4.5 mm

Clamping range (MT): 2.1–2.6 mm

Weight: 0.2 g

Packaging unit: 1000 pcs. (.11 = 10,000 pcs.)

Type: 98050

Ref. No.: 562870

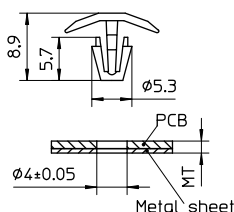

562870

Linear LED Constant Current Drivers

Please visit our homepage for details for suitable
LED constant current drivers: www.vossloh-schwabe.com

The values contained in this data sheet can change due to technical innovations. Any such changes will be made without separate notification.

Assembly and Safety Information

Installation must be carried out under observation of the relevant regulations and standards. The LED modules are designed for operation within a casing or luminaire. Installation must be carried out in a voltage-free state (i.e. disconnection from the mains). The following advice must be observed; non-observance can result in the destruction of the LED assembly modules, fire and/or other hazards.

- Consider safety regulations acc. EN 60598 in the luminaire design, especially when the operating LED driver is not galvanic isolated.
 - In mode of operation regard to sufficient isolation.
 - Live parts must not be touched in operation mode.
- ESD (electrostatic discharge) protection measures must be observed when handling and installing the LED modules. See VS's application notes on ESD protection.
- Adequate anti-static electricity measures, including the use of conductive shoes, ionizers, work bench grounding, wrist straps, flooring and stools should be used.
- LED assembly modules must not be subjected to any undue mechanical stress, e. g.:
 - do not treat as bulk cargo
 - avoid shear and compressive forces during handling and installation
 - do not damage circuit paths
 - avoid any pressure on the light emitting surface
- Safe operation only possible by the use of external constant current sources (I_{max} , see table "Electrical Characteristics").
- Operation only with power supply units that feature the following protection:
 - Short-circuit protection
 - Overload protection
 - Overheating protection
- The module can be fixed with M4 screws. Fixation only with flat or cylinder head screws (M4) (no countersunk screws)
Max. torque: 1.2 Nm (M4)
- Please ensure the correct polarity of the leads prior to commissioning. Reversed polarity can destroy the modules.
- For interconnection the LED modules is equipped with push-in terminals. (WAGO 2060 for top side connections, BJB 46.111.1001.50 for bottom side connection, Small top connector WAGO 2065)
- Safety regulations acc. to EN 60598 (or further standards) has to be observed if the maximum output voltage exceed the permitted touchable value.
- Measurement tolerances:
 - luminous flux: $\pm 7\%$
 - voltage: $\pm 3\%$
 - CRI: ± 1
- The following points must be observed when connecting LED modules in parallel:
 - All LED strings that are wired in parallel must contain the same number of LEDs (symmetrical loading).
 - Owing to differing forward biases, there can be a difference of up to 10% in brightness between modules connected in parallel.



- To ensure problem-free operation, the specified maximum temperature at the t_p point (see "Operating Life") must be observed (and measured in accordance with EN 60598-1). To satisfy this point, it may be necessary to put measures in place to ensure any heat is dissipated from the PCB to the environment.
- In the event of outdoor applications or applications in damp locations, care must be taken to protect LED assembly modules against humidity, splashes and jets of water. Any corrosion damage resulting from humidity or contact with condensation will not be recognised as a defect or manufacturing fault. LED assembly modules are not specially protected against foreign bodies or dust. Depending on the type of application, further protection must be ensured to prevent dust and foreign bodies from entering.
- Due to the manufacturing process, the PCBs of the LED assembly modules can have sharp edges and corners. Care must therefore be taken during handling and installation to avoid injury.
- For optimal load of used constant current driver the modules can only be connected in series. The quantity of LED modules is limited by the sum of forward voltage and the capacity of used constant current driver. Safety regulations acc. to EN 60598 has to be observed if the sum of forward voltage exceed the permitted touchable value.
- Operating LED modules in the presence of certain chemical substances or in chemically enriched (aggressive) environments can impair module functionality or even cause total module failure. Detailed information can be found in our "Chemical Incompatibility" PDF on our website www.vossloh-schwabe.com
- The photobiological safety of the LED modules must be classified into risk groups in accordance with EN 62471: 2008.
Rating in accordance with IEC / TR 62778: risk group 1

CCT	Max. operating current for risk group 1 (mA)	E threshold for higher operating currents to be risk group 1 lx
≤ 4000	500	1335
5000	500	1103
6500	459	867

Applied Standards

EN 62031

LED modules for general lighting – Safety specifications



EN 62471

Photobiological safety of lamps and lamp systems

Product Guarantee

- 5 years
- The conditions for the Product Guarantee of the Vossloh-Schwabe Group shall apply as published on our homepage (www.vossloh-schwabe.com). We will be happy to send you these conditions upon request.

The values contained in this data sheet can change due to technical innovations. Any such changes will be made without separate notification.