

LED DOWNLIGHT PRIME K C

FOR RESIDENTIAL LIGHTING



DOWNLIGHT PRIME K C

LED Recessed Mounted Downlight

Use of modern LED technology in conventional downlight applications provides an optimal light distribution and extended life time all at an affordable price.

VS LED downlights are fully compatible with existing conventional downlight infrastructure, and are the perfect choice for both new and replacement markets.

■ PRIME K C

- COB technology
- High efficiency of up to 150 lm/W
- Slim design for easy installation in low false ceiling
- High flexibility by free choice of LED driver
- High colour rendering index CRI: ≥ 82



LED Downlight Prime K C

- **LONG SERVICE LIFE TIME: UP TO 78,000 hrs.**
- **UP TO 150 lm/W**
- **HIGH QUALITY COB TECHNOLOGY**
- **ENEC APPROVED**
- **5 YEARS GUARANTEE**
more information under www.vossloh-schwabe.com
- **MADE IN GERMANY**



Prime K C – 4"

Indoor LED recessed mounted downlight with aluminium reflector

Reflector: Ø 118 mm, aluminium

Material: aluminium diecast, powder coating: epoxid

Flange colour: white (RAL 9003)

Front part: glass

Degree of protection: IP44

(casing: IP20, front part: IP44)

Use of external LED constant current driver

Operating current range: up to 700 mA

Voltage range: 30–40 V DC / TW 24–32 V DC

Typ. colour accuracy initially: 3 SDCM

Operating life:

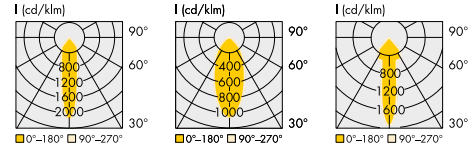

Clear

Diffuse

Partly diffuse

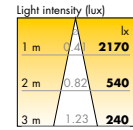
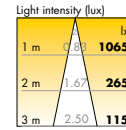
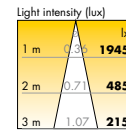

24-C*

50-D*

25-PD*

* $E_{true} = \Phi_{data\ sheet} \cdot E_{nominal} : 1000$

E_{true} for example 570406 at 500 mA / 3 m distance
215 lx · 2266 lm : 1000 = 487 lx

Standard Types 1-Channel DL-PRIME-K-4-C-xxx-C-CC

Lumen maintenance	$t_a = 25\ ^\circ\text{C}$			$t_a = 40\ ^\circ\text{C}$		
	350 mA in hrs.	500 mA in hrs.	700 mA in hrs.	350 mA in hrs.	500 mA in hrs.	700 mA in hrs.
L90/B10	61,000	52,000	42,000	58,000	48,000	38,000
L80/B10	66,000	56,000	44,000	62,000	51,000	40,000
L70/B10	76,000	65,000	54,000	71,000	61,000	49,000

Tunable White 2-Channel DL-PRIME-K-4-C-TW-CC

	Lumen maintenance	$t_a = 25\ ^\circ\text{C}$		$t_a = 40\ ^\circ\text{C}$	
		350 mA in hrs.	500 mA in hrs.	350 mA in hrs.	500 mA in hrs.
CW+WW (CH1+CH2)	L90/B10	89,000	70,000	76,000	56,000
	L80/B10	>100,000	>100,000	>100,000	84,000
	L70/B10	>100,000	>100,000	>100,000	>100,000

Applied Standards

- EN 60598-1:2015
- EN 60598-2-2:1989
- EN 60598-2-2:2012
- EN 62471:2008

Electrical Characteristics

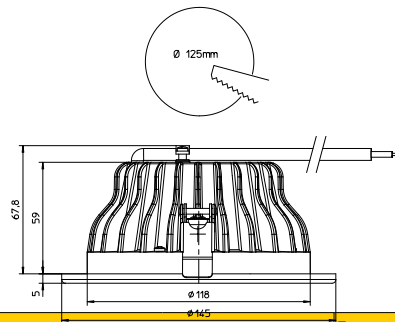

Type	Typ. voltage DC (V)			Typ. power consumption (W)		
	350 mA	500 mA	700 mA	350 mA	500 mA	700 mA
DL-PRIME-K-4-C-xxx-C-CC	32,4	33,0	33,8	11,3	16,5	23,6
DL-PRIME-K-4-C-TW-CC CW (CH1)	27,7	28,4	–	9,7	14,2	–
DL-PRIME-K-4-C-TW-CC WW (CH2)	27,3	27,8	–	9,5	13,9	–

Voltage and power tolerance: ± 10%

Maximum Ratings

Exceeding the maximum ratings can lead to reduction of service life or destruction of the modules.

Type	Max. operating current mA	Ambient temperature range		Storage temperature range		Max. allowed repetitive peak current mA
		°C min.	°C max.	°C min.	°C max.	
All types	700	-20	+45	-40	+60	1400

The values contained in this data sheet can change due to technical innovations. Any such changes will be made without separate notification.

Prime K C – 4"

Optical Characteristics

Type	Ref. No.	Colour	Correlated colour temperature K	Typ. luminous flux* (lm) and efficiency* (lm/W) at						Beam angle °	Typ. CRI R _a	UGR 4H8H @350mA
				350 mA		500 mA		700 mA				
				lm	lm/W	lm	lm/W	lm	lm/W			
Clear												
DL-PRIME-K-4-C-830-C-CC**	570405	warm white	3000	1584	140	2198	133	2970	126	24	82	<22
DL-PRIME-K-4-C-840-C-CC**	570406	neutral white	4000	1632	144	2266	137	3053	129	24	82	<22
DL-PRIME-K-4-C-850-C-CC	570407	cool white	5000	1663	147	2308	139	3116	132	24	82	<22
Diffuse												
DL-PRIME-K-4-C-830-D-CC**	570408	warm white	3000	1422	126	1973	120	2660	113	50	82	<25
DL-PRIME-K-4-C-840-D-CC**	570409	neutral white	4000	1464	129	2030	123	2739	116	50	82	<25
DL-PRIME-K-4-C-850-D-CC**	570410	cool white	5000	1490	131	2072	125	2796	118	50	82	<25
TunableWhite												
DL-PRIME-K-4-C-TW-CC (CH1)	609030	cool white	6140	834	86	1156	81,4	–	–	56	85	
DL-PRIME-K-4-C-TW-CC (CH2)		warm white	2400	880	92,6	1221	87,8	–	–	52	79	
DL-PRIME-K-4-C-TW-CC (CH1+CH2)				3530	1673	87,6	2297	82,3	–	–	54	87

* Production tolerance of luminous flux and efficiency: ±10% | CCT 5700 K or downlights with partially diffuse front glass on request

** ENEC approved

The values contained in this data sheet can change due to technical innovations. Any such changes will be made without separate notification.

Prime K C – 6"

Indoor LED recessed mounted downlight with aluminium reflector

Reflector: Ø 165 mm, aluminium

Material: aluminium diecast, powder coating: epoxid

Flange colour: white (RAL 9003)

Front part: glass / PMMA (UGR<19)

Degree of protection: IP44

(casing: IP20, front part: IP44)

Use of external LED constant current driver

Operating current range: up to 700 mA

Voltage range: 30–40 V DC / TW 24–32 V DC

Typ. colour accuracy initially: 3 SDCM

Operating life:

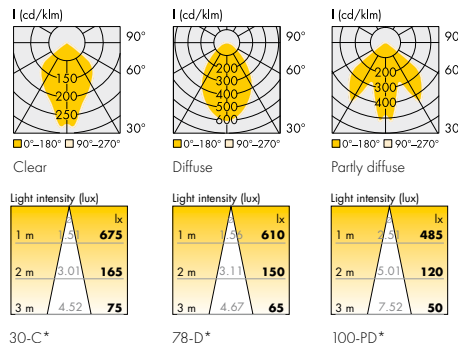

* E_{true} = $\Phi_{data\ sheet} \cdot E_{nominal} : 1000$
 E_{true} for example 570415 at 700 mA / 3 m distance
 75 lx · 3143 lm : 1000 = 236 lx

Lumen maintenance	t _a = 25 °C			t _a = 40 °C		
	350 mA in hrs.	500 mA in hrs.	700 mA in hrs.	350 mA in hrs.	500 mA in hrs.	700 mA in hrs.
L90/B10	63,000	54,000	46,000	60,000	51,000	43,000
L80/B10	68,000	59,000	49,000	64,000	54,000	45,000
L70/B10	78,000	68,000	60,000	74,000	64,000	55,000

Tunable White 2-Channel DL-PRIME-K-6-C-TW-D-CC

	Lumen maintenance	t _a = 25 °C			t _a = 40 °C		
		350 mA in hrs.	500 mA in hrs.	700 mA in hrs.	350 mA in hrs.	500 mA in hrs.	700 mA in hrs.
CC+WW (CH1+CH2)	L90/B10	97.000	80.000	58.000	84.000	67.000	44.000
	L80/B10	>100.000	>100.000	86.000	>100.000	>100.000	64.000
	L70/B10	>100.000	>100.000	>100.000	>100.000	>100.000	64.000

To comply with RG2, a minimum distance of 1.50 m must be maintained at 570414, 570415, 570416, and a minimum distance of 1.40 must be maintained at 570417, 570418, 570419.

Applied Standards

- EN 60598-1:2015
- EN 60598-2-2:1989
- EN 60598-2-2:2012
- EN 62471:2008

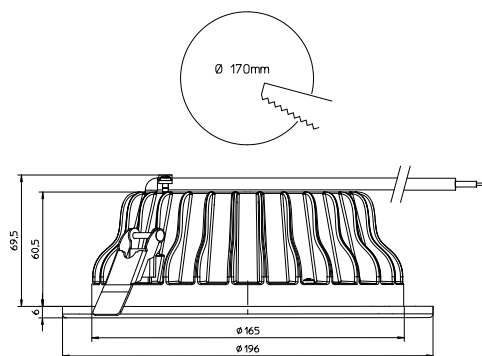

Electrical Characteristics

Type	Typ. voltage DC (V)			Typ. power consumption (W)		
	350 mA	500 mA	700 mA	350 mA	500 mA	700 mA
DL-PRIME-K-6-C-xxx-x-CC	32,4	33,0	33,8	11,3	16,5	23,6
DL-PRIME-K-6-C-TW-D-CC-CW (CH1)	27,8	28,5	29,3	9,7	14,2	20,5
DL-PRIME-K-6-C-TW-D-CC-VWV (CH2)	27,4	27,9	28,5	9,6	13,9	19,9

Voltage and power tolerance: ± 10%

Maximum Ratings

Exceeding the maximum ratings can lead to reduction of service life or destruction of the modules.

Type	Max. operating current mA	Ambient temperature range °C min. / °C max.	Storage temperature range °C min. / °C max.	Max. allowed repetitive peak current mA
DL-PRIME-K-6-C-xxx-x-CC	700	-20 / +45	-40 / +60	1400
DL-PRIME-K-6-C-TW-D-CC	700	-20 / +45	-40 / +60	CH1 1200 / CH2 1600

The values contained in this data sheet can change due to technical innovations. Any such changes will be made without separate notification.

Prime K C – 6"

Optical Characteristics

Type	Ref. No.	Colour	Correlated colour temperature K	Typ. luminous flux* (lm) and efficiency* (lm/W) at						Beam angle °	Typ. CRI R _a	UGR @350mA 4H8H
				350 mA		500 mA		700 mA				
				lm	lm/W	lm	lm/W	lm	lm/W			
Clear												
DL-PRIME-K-6-C-830-C-CC**	570414	warm white	3000	1626	144	2261	137	3053	129	30	82	<23
DL-PRIME-K-6-C-840-C-CC**	570415	neutral white	4000	1679	148	2329	141	3143	133	30	82	<23
DL-PRIME-K-6-C-850-C-CC**	570416	cool white	5000	1710	150	2377	144	3206	135	30	82	<23
Diffuse												
DL-PRIME-K-6-C-830-D-CC**	570417	warm white	3000	1490	131	2067	125	2791	118	78	82	<25
DL-PRIME-K-6-C-840-D-CC**	570418	neutral white	4000	1532	135	2130	128	2875	121	78	82	<25
DL-PRIME-K-6-C-850-D-CC**	570419	cool white	5000	1542	137	2172	132	2933	123	78	82	<25
UGR												
DL-PRIME-K-6-C-830-U-CC	ibid	warm white	3000	1525	135	–	–	–	–	17	80	≤19
DL-PRIME-K-6-C-840-U-CC	609014	neutral white	4000	1575	139	–	–	–	–	17	80	≤19
TunableWhite												
DL-PRIME-K-6-C-TW-D-CC (CH1)	572160	cool white	6670	860	88,7	1191	83,9	1590	77,6	76	87	<25
DL-PRIME-K-6-C-TW-D-CC (CH2)		warm white	2500	935	97,4	1289	92,7	1714	86,1	76	80	<25
DL-PRIME-K-6-C-TW-D-CC (CH1+CH2)				3780	1761	91,7	2394	85,8	3117	77,7	76	87

* Production tolerance of luminous flux and efficiency: ±10% | CCT 5700 K or downlights with partially diffuse front glass on request

**ENEC approved

The values contained in this data sheet can change due to technical innovations. Any such changes will be made without separate notification.

Prime K C – 8"

Indoor LED recessed mounted downlight with aluminium reflector

Reflector: Ø 206 mm, aluminium

Material: aluminium diecast,
powder coating: epoxid

Flange colour: white (RAL 9003)

Front part: glass / PMMA (UGR<19)

Degree of protection: IP44

(casing: IP20, front part: IP44)

Use of external LED constant current driver

Operating current range: up to 1400 mA

Voltage range: 30–40 V DC / TW 24–32 V DC

Typ. colour accuracy initially: 3 SDCM

Operating life:

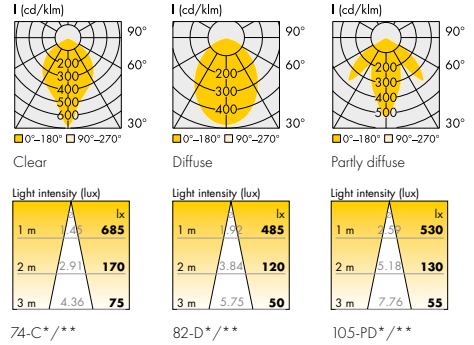
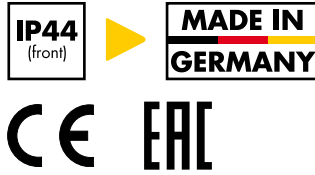

* E_{true} = $\Phi_{data\ sheet} \cdot E_{nominal} : 1000$
E_{true} for example 570424 at 900 mA / 3 m distance
75 lx · 3057 lm : 1000 = 229 lx

Lumen maintenance	t _a = 25 °C				t _a = 40 °C			t _a = 35 °C
	700 mA in hrs.	900 mA in hrs.	1050 mA in hrs.	1400 mA in hrs.	700 mA in hrs.	900 mA in hrs.	1050 mA in hrs.	1400 mA in hrs.
L90/B10	51,000	44,000	39,000	35,000	45,000	38,000	34,000	28,000
L80/B10	55,000	47,000	43,000	37,000	49,000	41,000	37,000	31,000
L70/B10	68,000	59,000	52,000	44,000	60,000	51,000	45,000	38,000

Tunable White 2-Channel DL-PRIME-K-8-C-TW-D-CC

	Lumen maintenance	t _a = 25 °C	t _a = 40 °C
		700 mA in hrs.	700 mA in hrs.
CC+WW (CH1+CH2)	L90/B10	67,000	55,000
	L80/B10	>100,000	82,000
	L70/B10	>100,000	>100,000

To comply with RG2, a minimum distance of 2.00 m must be maintained at 570423, 570424, 570425, and a minimum distance of 1.60 must be maintained at 570426, 570427, 570428.

Applied Standards

- EN 60598-1:2015
- EN 60598-2-2:1989
- EN 60598-2-2:2012
- EN 62471:2008

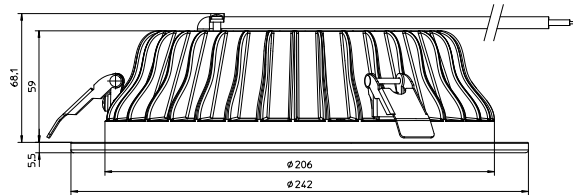
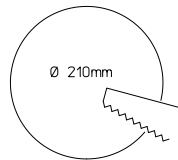

Electrical Characteristics

Type	Typ. voltage DC (V)					Typ. power consumption (W)				
	500mA	700 mA	900 mA	1050 mA	1400 mA	500mA	700 mA	900 mA	1050 mA	1400 mA
DL-PRIME-K-8-C-xxx-x-CC	–	33,2	33,9	34,2	35,1	–	23,2	31,9	35,9	49,1
DL-PRIME-K-8-C-TW-D-CC CW (CH1)	28,5	29,3	–	–	–	14,2	20,6	–	–	–
DL-PRIME-K-8-C-TW-D-CC WW (CH2)	28,0	28,7	–	–	–	14,0	20,0	–	–	–

Voltage and power tolerance: ± 10%

Maximum Ratings

Exceeding the maximum ratings can lead to reduction of service life or destruction of the modules.

Type	Ambient temperature range		Storage temperature range		Max. allowed repetitive peak current mA
	°C min.	°C max.	°C min.	°C max.	
DL-PRIME-K-8-C-xxx-x-CC	-20	+35	-40	+60	2000
DL-PRIME-K-8-C-TW-D-CC	-20	+35	-40	+60	CH1 1200 / CH2 1600

The values contained in this data sheet can change due to technical innovations. Any such changes will be made without separate notification.

Prime K C – 8"

Optical Characteristics

Type	Ref. No.	Colour	Correlated colour temp. K	Typ. luminous flux* (lm) and efficiency* (lm/W) at						Beam angle °	Typ. CRI Ra	UGR @700mA 4H8H
				700 mA	1050 mA	1400 mA	lm/W	lm/W	lm/W			
Clear												
DL-PRIME-K-8-C-830-C-CC**	570423	warm white	3000	2969	127	4290	119	5455	111	74	82	<24
DL-PRIME-K-8-C-840-C-CC**	570424	neutral white	4000	3057	131	4421	123	5617	114	74	82	<24
DL-PRIME-K-8-C-850-C-CC**	570425	cool white	5000	3113	135	4504	126	5727	116	74	82	<24
Diffuse												
DL-PRIME-K-8-C-830-D-CC**	570426	warm white	3000	2785	120	4025	112	5115	104	82	82	<26
DL-PRIME-K-8-C-840-D-CC**	570427	neutral white	4000	2865	112	4140	115	5265	107	82	82	<26
DL-PRIME-K-8-C-850-D-CC**	570428	cool white	5000	2920	126	4225	118	5365	109	82	82	<26
UGR												
DL-PRIME-K-8-C-830-U-CC	608938	warm white	3000	2785	120	–	–	–	–	23	80	≤19
DL-PRIME-K-8-C-840-U-CC	572162	neutral white	4000	2865	123	–	–	–	–	23	80	≤19
TunableWhite												
DL-PRIME-K-8-C-TW-D-CC (CH1)	572161	kaltweiß	6680	1593	77,3	–	–	–	–	80	86	<24
DL-PRIME-K-8-C-TW-D-CC (CH2)		warm white	2490	1741	87,1	–	–	–	–	83	80	<24
DL-PRIME-K-8-C-TW-D-CC (CH1+CH2)				3760	3231	80,0	–	–	–	–	82	88

* Production tolerance of luminous flux and efficiency: ±10% | CCT 5700 K or downlights with partially diffuse front glass on request

**ENEC approved

LED Constant Current Drivers

You will find more information about our LED drivers on our website: www.vossloh-schwabe.com

Max. output W	Ref. No.	Type	Version	Output current mA	Output voltage DC V	Dimensions LxWxH (mm)	Max. service life hrs.
21	186925*	ECXe 500.381	ON/OFF	500	30–41	97x43x30	50,000
	187116**	ECXe 500.479	ON/OFF / DIP switch	150–500	10–42	97x43x30	100,000
25	187113	ECXe 500.476	ON/OFF	500	28–42	Ø55x26.5	100,000
	187114	ECXe 600.477	ON/OFF	600	28–42	Ø55x26.6	100,000
32	187115	ECXe 700.478	ON/OFF	700	28–42	Ø60x28	100,000
	187117***	ECXe 800.480	ON/OFF / DIP switch	600-800	28–40	97x43x26	100,000
36	186929*	ECXe 900.385	ON/OFF	900	30–40	97x43x30	50,000
38	186763	ECXd 1050.299	DALI/PUSH / DIP switch	300–1050	10–36	146.5x43.2x30.1	100,000
40	187217	ECXd 1050.560	DALI/PUSH / DIP switch	300–1050	38–54	132x79x30	100,000
42	186930*	ECXe 1050.386	ON/OFF	1050	31–40	97x43x30	50,000
	187215	ECXe 1050.558	ON/OFF / DIP switch	300–1050	40–44	132x79x30	100,000
	187119***	ECXe 1050.482	ON/OFF / DIP switch	850-1050	28–40	97x43x26	100,000
30	187257	ECXd2 1050.583	NFC / DALI	350-1050	15-54	135x75,5x25	100,000
50	187258	ECXd 21400.584	NFC / DALI	600-1400	15-54	135x75,5x25	100,000

* Cord grip 186942 for protection class II required | ** Cord grip 187203 for protection class II required | *** Cord grip 187204 for protection class II required

The values contained in this data sheet can change due to technical innovations. Any such changes will be made without separate notification.

Logistic Details

Type	Packaging dimensions LxWxH (mm)	Packaging unit weight		MOQ/ Euro pallet pcs.
		pcs.	kg	
DL-PRIME-K-4-C-xxx-x-CC	150x150x79	1	0,42	210
DL-PRIME-K-6-C-xxx-x-CC	200x200x79	1	0,72	90
DL-PRIME-K-8-C-xxx-x-CC	247x247x79	1	1,10	72

CCT 5700 K or partially diffuse glass only with higher MOQs.

Comparison with Compact Fluorescent Lamps



Type	LED	CFL
Service lifetime	80,000 hrs.	10,000 hrs.
Prime K C – 4"	12 W	2 x 13 W
Prime K C – 6"	17 W	2 x 18 W
Prime K C – 8"	34 W	2 x 26 W

Product Code Description

DL-PRIME-K-4-C-xxx-x-CC

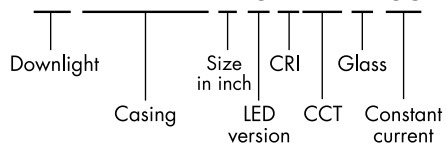

EPREL information

Containing product	Light Source	EPREL Regi. No.	EE Class
DL-PRIME-K-4-C-830-C/D-CC, DL-PRIME-K-6-C-830-C/D-CC/U-CC	VCA2-128-830	857322	D
DL-PRIME-K-4-C-840-C/D-CC, DL-PRIME-K-6-C-840-C/D-CC/U-CC	VCA2-128-840	857331	C
DL-PRIME-K-4-C-850-C/D-CC, DL-PRIME-K-6-C-850-C/D-CC	VCA-127-850	856218	D
DL-PRIME-K-8-C-830-C/D-CC/U-CC	VCA2-1211-830	857390	D
DL-PRIME-K-8-C-840-C/D-CC/U-CC	VCA2-1211-840	857397	D
DL-PRIME-K-8-C-850-C/D-CC	VCA2-1210-850	856272	D
DL-PRIME-K-6-C/K-8-C-TW-D-CC	TW28200608AJ	932860	F

The values contained in this data sheet can change due to technical innovations. Any such changes will be made without separate notification.

Safety and Installation Instructions

General safety and installation instructions for luminaires

The following instructions must be observed. Non-observance can result in personal injury and damage to property or can damage both luminaires and control gear. In such cases, the manufacturer's warranty as well as liability will be invalidated.

General Instructions

- Please read these instructions prior to installation/commissioning and keep them safe for future use.
- Any improper use or modification will invalidate the manufacturer's warranty and liability as well as any warranty claims.
- The luminaire contains integrated and non-exchangeable LED light sources. The light source of this luminaire cannot be replaced. When the light source has reached the end of its service life, the entire luminaire must be replaced.
- Care must be taken to ensure the luminaire is operated only using the supplied Vossloh-Schwabe control gear and accessories or using an alternative brand of approved control gear.
- If the luminaire is marked with SELV, only control gear with SELV characteristics may be used.
- Children must be prevented from playing with or near the luminaire.

Installation and operating instructions

- Installation of this luminaire may be undertaken only by authorised and suitably trained staff in accordance with any country-specific regulations.
- Installation must be carried out only after disconnecting the device from mains voltage, i.e. in a voltage-free state.
- Depending on the site of operation, the degree of protection (IPxx) will have to be observed during installation.
- Please ensure that the correct supply voltage is applied by checking it against the voltage requirements of the luminaire and the driver.
- For the purpose of commissioning, please ensure the correct polarity of the connecting leads. Incorrect polarity can destroy the modules.
- For trouble-free operation, it is important to ensure that the permissible ambient temperature range (t_a) as stipulated in the datasheet is not exceeded. Exposure to sunlight can increase the ambient temperature.
- Only ever operate the luminaire with all protective covers in place.
- Given functional problems, please contact your Vossloh-Schwabe representative. Should the power supply cable be damaged, please scrap the luminaire and/or contact your VS representative.
- On contact with moisture or condensation, any resulting corrosive damage will not be recognised as a product flaw or manufacturer's defect.
- Connecting luminaires (LED modules) to supply units that are already connected to the mains can result in long-term damage. Secondary switching is not permissible.
- Touchable luminaire parts can reach high temperatures (risk of burning/injury).
- Highly flammable materials (e.g. cladding or insulation material) must be kept away from the luminaire.

- Please ensure protective ESD (electrostatic discharge) measures are taken when handling and installing the luminaire – see VS "ESD Protection" application notes.

Cleaning instructions

- Depending on the conditions on site, the luminaire must be cleaned on a regular basis.
- Never use any flammable, abrasive, harsh or corrosive cleaning liquids.
- Prior to cleaning the luminaire, please ensure it is disconnected from the mains and is given time to cool down.
- Once it has cooled down, the luminaire can be cleaned with a damp cloth.
- Let the luminaire dry fully before switching it back on.

Answers to technical questions can be found on our website at www.vossloh-schwabe.com or ask your Vossloh-Schwabe representative.

Safety symbols

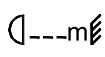
 Specifies the minimum clearance to flammable materials in the direction of radiation.



Indoor operation



Please ensure that the way the luminaire is positioned means there is no reason to expect anyone could look into it for a longer period of time with less clearance than stated in the datasheet.



Caution: risk of electric shock.

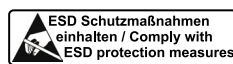

Caution: components with a risk of electrostatic charge.



Luminaire/voltage supply unit must not be covered with any thermally insulating materials or similar.

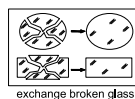

Any cover with damage must be replaced.

exchange broken glass

Product guarantee

- 5 years
- The conditions for the Product Guarantee of the Vossloh-Schwabe Group shall apply as published on our homepage (www.vossloh-schwabe.com). We will be happy to send you these conditions upon request.

The values contained in this data sheet can change due to technical innovations. Any such changes will be made without separate notification.