

CV LINEAR DALI2



PRIMELINE 24 V L DALI2

187058, 187059, 187060

Typical Applications

Built-in in linear luminaires for

- Office lighting
- Shop lighting

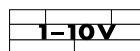

PrimeLine 24 V L DALI2

- **SELECTABLE OUTPUT CURRENT VIA DALI**
- **DIMMABLE: DALI (ED. 2) AND 1-10 V**
- **VERY LOW RIPPLE CURRENT: < 3%**
- **SUITABLE FOR BUILT-IN INTO FURNITURE**
- **SUITABLE FOR EMERGENCY ESCAPE LIGHTING SYSTEMS ACC. TO EN 50172**
- **LONG SERVICE LIFE:
UP TO 100,000 HRS.**
- **PRODUCT GUARANTEE: 5 YEARS**



PrimeLine 24 V L DALI2

Product features

- Linear casing shape

Functions

- The required current output can be chosen via DALI or 1–10 V.

Electrical features

- Mains voltage: 220–240 V ±10%
- Mains frequency: 50–60 Hz
- DC operation: 176–264 V, 0 Hz
- Push-in terminals: 0.2–1.5 mm²
- Power factor at full load: 0.95
- Secondary side switching of LED modules is not allowed.

Dimming

- PWM dimming at 1 kHz
- Optional analogue dimming via 1–10 V or DALI interface
- Dimming also possible with resistor (100 kΩ) at 1–10 V interface
- Dimming range: 1 to 100%

Safety features

- Protection against transient main peaks up to 2 kV (between L and N) and up to 4 kV (between L/N and PE)
- Electronic short-circuit protection
- Overload protection
- Overtemperature protection
- Degree of protection: IP20
- Protection class I

Packaging units

Ref. No.	Packaging unit		
	Pieces per box	Boxes per pallet	Weight g
187058	30	72	277
187059			310
187060			277

Product guarantee

- 5 years
- The conditions for the Product Guarantee of the Vossloh-Schwabe Group shall apply as published on our homepage (www.vossloh-schwabe.com). We will be happy to send you these conditions upon request.

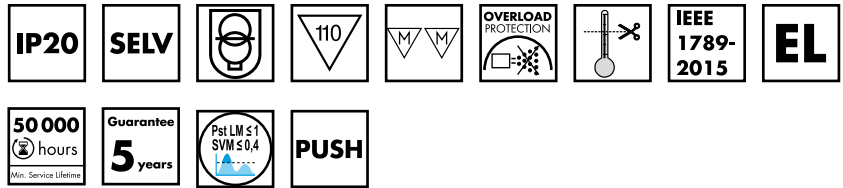

Applied standards

- EN 61347-1
- EN 61347-2-13
- EN 61547
- EN 61000-3-2
- EN 61000-3-3
- EN 55015
- EN 62386 ed. part 101/102/207



Dimming

PWM



Dimensions

- Casing: M10
- Length: 359 mm
- Width: 30 mm
- Height: 21 mm

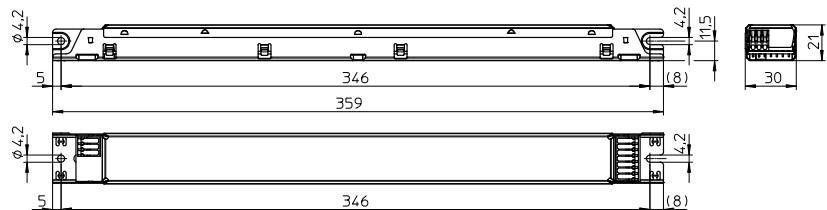

Cord grip for M10

Available for independent operation
Packaging unit: 100 pcs. (= 50 pairs)

Ref. No.: 187073

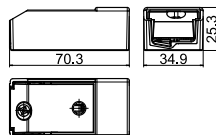

The values contained in this data sheet can change due to technical innovations. Any such changes will be made without separate notification.

Electrical characteristics

Max. output W	Type	Ref. No.	Voltage 50–60 Hz V	Mains current mA	Inrush current A / μ s	Current output DC mA (\pm 5%)	Voltage output DC (V)	THD at full load % (230 V)	Efficiency at full load % (230 V)	Ripple 100 Hz %
70	EDXd 170/24.081	187058	220–240	323–390	15 / 600	0–2900	24	< 15	> 87	< 3
120	EDXd 1120/24.082	187059		759–480	30 / 250	0–5000			> 92	
30	EDXd 130/24.083	187060		180–161	30 / 250	0–1250			> 87	

Maximum ratings

Exceeding the maximum ratings can lead to reduction of service life or destruction of the drivers.

Ref. No.	Ambient temperature range		Operation humidity range		Storage temperature range		Storage humidity range		Max. operation temperature at t_c point °C	Degree of protection
	°C min.	°C max.	% min.	% max.	°C min.	°C max.	% min.	% max.		
187058	-25	+50	5	60	-30	+80	5	95	+75	IP20
187059			20	60	-40	+80			+85	
187060			20	60	-25	+50			+75	

Expected service life time

at operation temperatures at t_c point

Operation current	Ref. No. 187058, 187060		Ref. No. 187059	
	All	65 °C	75 °C	75 °C
hrs.	100,000	50,000	100,000	50,000

Product labels

<ul style="list-style-type: none"> ■ \oplus □ ■ L ■ N ■ da DALI ■ da 	<p>PRI $U_N = 220...240 V-$ $I_N = 370 mA$ $f_N = 0/50...60 Hz$ $\lambda = 0,95$ Range of application DC 176...264 V $I_{max} = 440 mA$ (DC operation)</p>	<p>VSL LIGHTING SOLUTIONS Vossloh-Schwabe Deutschland GmbH Wasenstrasse 25, D-73660 Urbach Electronic converter for LED LED控制装置 Type EDXd 170/24.081 Ref.-No. 187058 Made in Italy</p>	<p>EN 61347-1 EN 61347-2:13 EN 62384 EN 61547 EN 55015 EN 61000-3-2</p>	<p>PUSH DALI2</p> 	<p>$t_a = 25...50^\circ C$ $t_c = 75^\circ C$</p> <p>PRI, SEC: 0,5/1,5 mm² DALI, DIM: 0,2/1,5 mm² $\pm 0,5/0,5 mm$</p>	<p>SEC DIM - + U_{out} = 24 V=(C.V.) $I_{max} = 2900 mA$ $P_{max} = 70W$ SELV SEC - +</p>
---	---	--	--	---	--	--

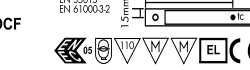
<ul style="list-style-type: none"> ■ \oplus □ ■ L ■ N ■ da DALI ■ da 	<p>PRI $U_N = 220...240 V-$ $I_N = 630 mA$ $f_N = 0/50...60 Hz$ $\lambda = 0,95$ Range of application DC 176...264 V $I_{max} = 730 mA$ (DC operation)</p>	<p>VSL LIGHTING SOLUTIONS Vossloh-Schwabe Deutschland GmbH Wasenstrasse 25, D-73660 Urbach Electronic converter for LED LED控制装置 Type EDXd 1120/24.082 Ref.-No. 187059 Made in Italy</p>	<p>EN 61347-1 EN 61347-2:13 EN 62384 EN 61547 EN 55015 EN 61000-3-2</p>	<p>PUSH DALI2</p> 	<p>$t_a = 25...50^\circ C$ $t_c = 85^\circ C$</p> <p>PRI, SEC: 0,5/1,5 mm² DALI, DIM: 0,2/1,5 mm² $\pm 0,5/0,5 mm$</p>	<p>SEC DIM - + U_{out} = 24 V=(C.V.) $I_{max} = 5000 mA$ $P_{max} = 120W$ SELV DIM - +</p>
---	---	---	--	---	--	---

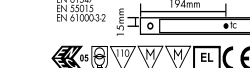
<ul style="list-style-type: none"> ■ \oplus □ ■ L ■ N ■ da DALI ■ da 	<p>PRI $U_N = 220...240 V-$ $I_N = 160 mA$ $f_N = 0/50...60 Hz$ $\lambda = 0,95$ Range of application DC 176...264 V $I_{max} = 190 mA$ (DC operation)</p>	<p>VSL LIGHTING SOLUTIONS Vossloh-Schwabe Deutschland GmbH Wasenstrasse 25, D-73660 Urbach Electronic converter for LED LED控制装置 Type EDXd 130/24.083 Ref.-No. 187060 Made in Italy</p>	<p>EN 61347-1 EN 61347-2:13 EN 62384 EN 61547 EN 55015 EN 61000-3-2</p>	<p>PUSH DALI2</p> 	<p>$t_a = 25...50^\circ C$ $t_c = 65^\circ C$</p> <p>PRI, SEC: 0,5/1,5 mm² DALI, DIM: 0,2/1,5 mm² $\pm 0,5/0,5 mm$</p>	<p>SEC DIM - + U_{out} = 24 V=(C.V.) $I_{max} = 1250 mA$ $P_{max} = 30 W$ SELV SEC - +</p>
---	---	--	--	---	--	---

The values contained in this data sheet can change due to technical innovations. Any such changes will be made without separate notification.

Typ. performance graphs for 187058 / Type EDXd 170/24.081

Working area

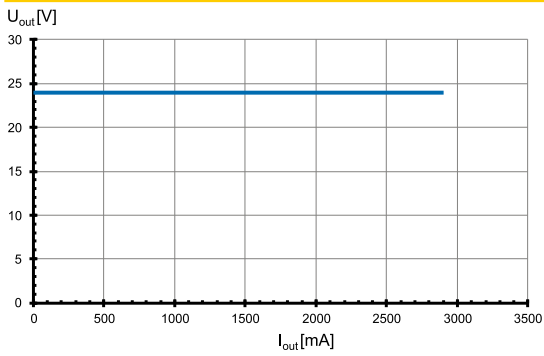

Efficiency

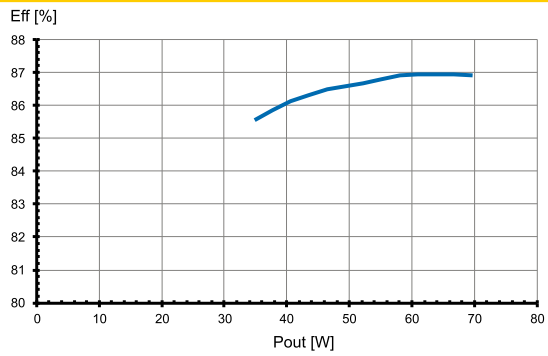

Power factor

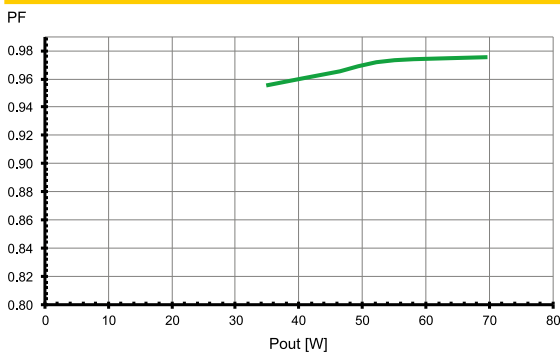

Total harmonic factor (THD)

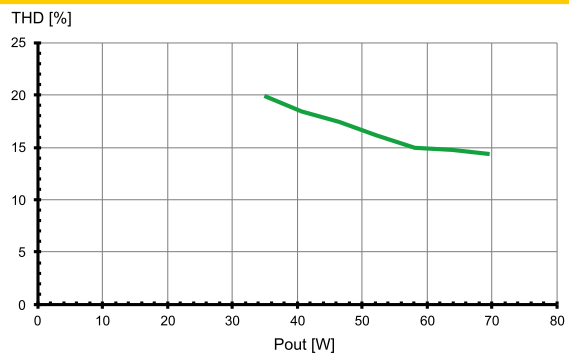

Typ. performance graphs for 187059 / Type EDXd 1120/24.082

Working area

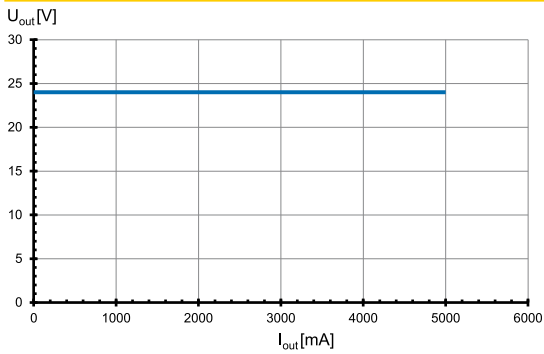

Efficiency

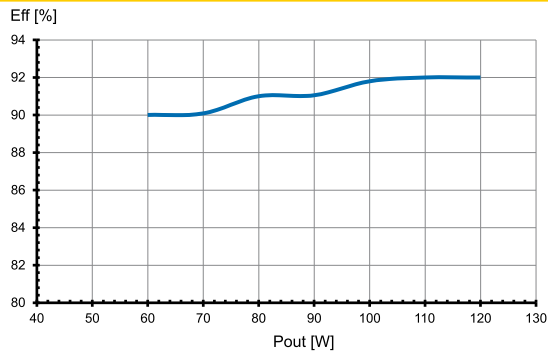

Power factor

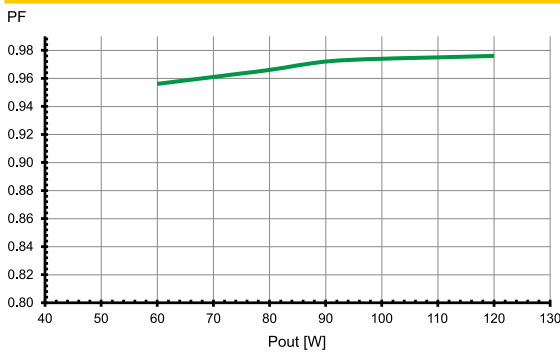

Total harmonic factor (THD)

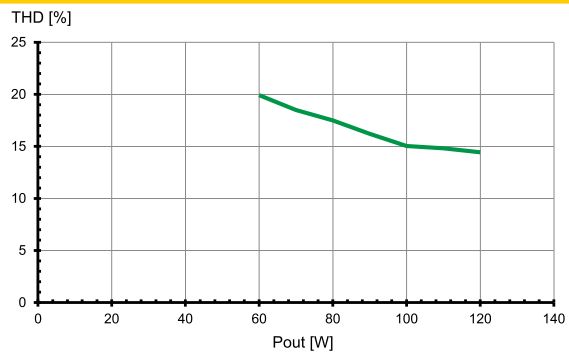

The values contained in this data sheet can change due to technical innovations. Any such changes will be made without separate notification.

Typ. performance graphs for 187060/ Type EDXd 130/24.083

Working area

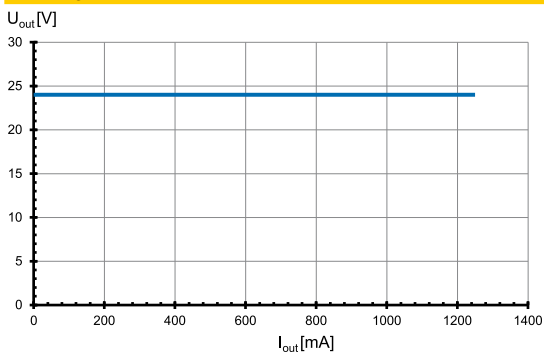

Efficiency

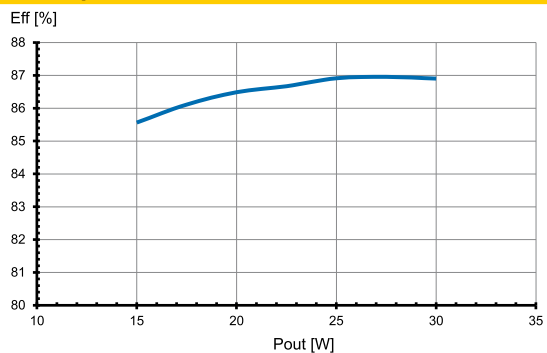

Power factor

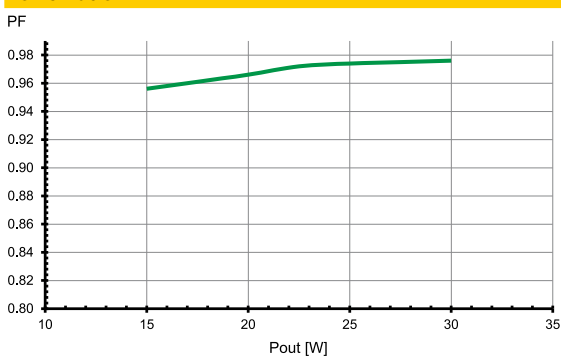

Total harmonic factor (THD)

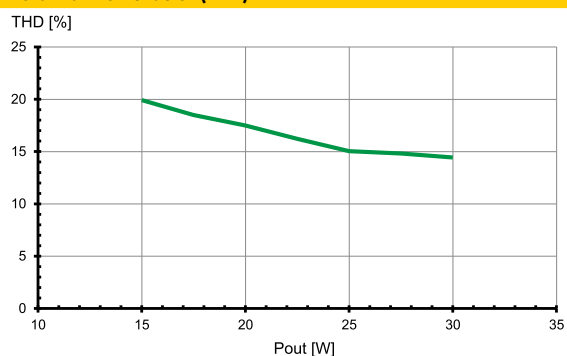

Safety functions

- Transient mains peaks protection:
 - Values are in compliance with EN 61547 (interference immunity).
 - Surges between L–N: up to 2 kV
 - Surges between L/N–PE: up to 4 kV
- Short-circuit protection: The control gear is protected against permanent short-circuit with automatic restart function.
- Overload protection: The control gear only works in range of rated output power and voltage problemfree. Please check before switch-on mains power supply that the selected LED load is suitable (see Electrical Characteristics on data sheet).
- Overheating: The control gear has overheating protection acc. to IEC 61347-1 C 5e). In case of overheating the control gear will shut down. For restart switch of the mains for 1 min. and start again.
- If any of the above mentioned safety functions will be triggered, disconnect the control gear from the power supply then find and eliminate the cause of the problem.

DC and emergency lighting operation

- The control gears are suitable for direct voltage operation (DC). Reliable DC operation is guaranteed if the specified working area of LED driver is maintained.
- DC range: 176–264 V
- Light level at DC operation (E_{OFI}): 100% (not adjustable)
- DC operation: 3 hrs. (acc. to EN 50172)

The values contained in this data sheet can change due to technical innovations. Any such changes will be made without separate notification.

Assembly and Safety Information

Installation must be carried out under observation of the relevant regulations and standards. Installation must be carried out in a voltage-free state (i.e. disconnection from the mains). The following advices must be observed; non-observance can result in the destruction of the LED drivers, fire and/or other hazards.

Mandatory regulations

- DIN VDE 0100
- EN 60598-1

Mechanical mounting

- Mounting position: Built-in: Any position inside a luminaire is allowed
Independent application: Drivers are not allowed to use for independent applications
- Mounting location: LED drivers are designed for integration into luminaires or comparable devices.
Installation in outdoor luminaires: degree of protection for luminaire with water protection rate ≥ 4 (e.g. IP54 required).
- Degree of protection: IP20
- Clearance: Min. 0.10 m from walls, ceilings and insulation
- Surface: Solid and plane surface for optimum heat dissipation required.
- Heat transfer: If the driver is destined for installation in a luminaire, sufficient heat transfer must be ensured between the driver and the luminaire casing. LED drivers should be mounted with the greatest possible clearance to heat sources. During operation the temperature measure at the driver's t_c point must not exceed the specified maximum value.
- Fastening: Using M4 screws in the designated holes
- Tightening torque: 0.2 Nm

Electrical installation

- Connection terminals: Push-in terminals for rigid or flexible conductors with a section of 0.2–1.5 mm²
- Stripped length: 8.5–10 mm
- Wiring: The mains conductor within the luminaire must be kept short (to reduce the induction of interference). Mains and lamp conductors must be kept separate and if possible should not be laid in parallel to one another.
- Polarity: Please ensure the correct polarity of the leads prior to commissioning. Reversed polarity can destroy the modules.
- Through-wiring: Is not allowed.
- Secondary load: The sum of forward voltages of LED loads has to be within the tolerances which are mentioned in the table "Electrical Characteristics" in this data sheet.

Wiring diagram:

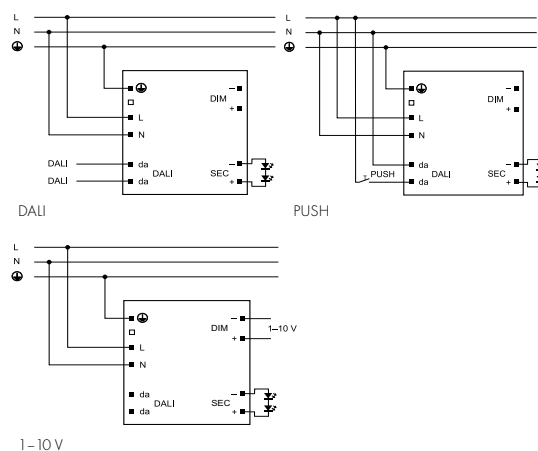

Selection of automatic cut-outs for VS LED drivers

- Dimensioning automatic cut-outs
High transient currents occur when an LED driver is switched on because the capacitors have to load. Ignition of LED modules occurs almost simultaneously. This also causes a simultaneous high demand for power. These high currents when the system is switched on put a strain on the automatic conductor cut-outs, which must be selected and dimensioned to suit.
- Release reaction
The release reaction of the automatic conductor cut-outs comply with VDE 0641, part 11, for B, C characteristics. The values shown in the following tables are for guidance purposes only and are subject to system-dependent change.
- No. of LED drivers
The maximum number of VS LED drivers applies to cases where the devices are switched on simultaneously. Specifications apply to single-pole fuses. The number of permissible drivers must be reduced by 20% for multi-pole fuses. The considered circuit impedance equals 400 m Ω (approx. 20 m [2.5 mm²] of conductor from the power supply to the distributor and a further 15 m to the luminaire).

Type	Ref. No.	Automatic cut-out type and possible no. of VS drivers pcs.					
		Cut-out type B			Cut-out type C		
		B 10 A	B 16 A	B 20 A	C 10 A	C 16 A	C 20 A
EDXd 170/24.081	187058	8	13	17	14	22	28
EDXd 1120/24.082	187059	9	15	16	15	25	31
EDXd 130/24.083	187060	9	15	16	15	25	31

- To limit capacitive inrush currents the current carrying capacity of each circuit breaker (fuse) can be increased by a factor of 2.5 with the help of our ESB (Ref. No.: 149820, 149821, 149822) inrush current limiters.

The values contained in this data sheet can change due to technical innovations. Any such changes will be made without separate notification.