

# CC COMPACT DIP SWITCH



## COMFORTLINE DIP SWITCH C

187691

### Typical Applications

Built-in in compact luminaires for

- Shop lighting
- Office lighting
- Residential lighting
- Downlights



### ComfortLine DIP Switch C

- **SELECTABLE OUTPUT CURRENT VIA DIP SWITCH**
- **VARIOUS CORD GRIPS CAN BE FITTED**
- **SELV**
- **SUITABLE FOR EMERGENCY ESCAPE LIGHTING SYSTEMS ACC. TO EN 50172**
- **LONG SERVICE LIFE: UP TO 100.000 HRS.**
- **PRODUCT GUARANTEE: 5 YEARS**



## ComfortLine DIP Switch C

### Product features

- Compact casing shape

### Functions

- Selectable current output by DIP Switch
- Suitable for central battery system for emergency lighting acc. to EN 50172

### Electrical features

- Mains voltage: 220–240 V ±10%
- Mains frequency: 50–60 Hz, 0 Hz
- DC Operation: 176–276 V (range of application)
- Push-in terminals:  
Input: 0.75–1.5 mm<sup>2</sup>  
Output: 0.5–1.5 mm<sup>2</sup>
- Power factor at full load: > 0.95
- Open circuit voltage (U<sub>max.</sub>): 60 V
- Secondary side switching of LED modules is not allowed.

### Safety features

- Protection against transient main peaks up to 1 kV (between L and N)
- Electronic short-circuit protection
- Overload protection
- Degree of protection: IP20
- Protection class II
- SELV
- SVM: < 0.4
- PstLM: < 1

### Packaging units

Ref. No.	Packaging unit		Weight g
	Pieces per box	Boxes per pallet	
187691	100	36	80

### Product guarantee

- 5 years for operation at recommended operation temperature (see table for expected service life time on the next page)
- The conditions for the Product Guarantee of the Vossloh-Schwabe Group shall apply as published on our homepage ([www.vossloh-schwabe.com](http://www.vossloh-schwabe.com)). We will be happy to send you these conditions upon request.

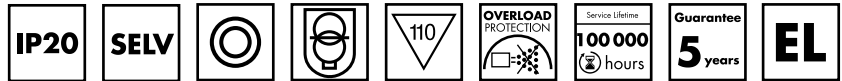
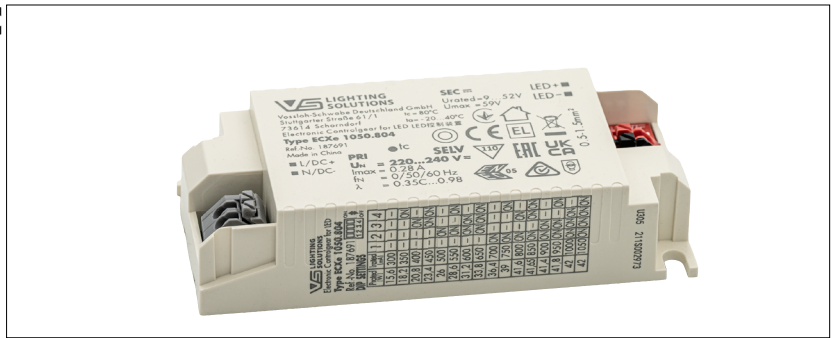

### Isolation

Symbol	Description
	Installation type: Built-in Double isolated
<b>SELV</b>	The isolation type between the input and the output power circuits in the LED driver: SELV output

### Applied standards

- EN 61347-1
- EN 61347-2-13
- EN 61547
- EN 61000-3-2/EN 61000-3-3
- EN 62384
- EN 55015
- EN 61000-4-2/EN 61000-4-5



### Dimensions

Ref. No.	Casing	Length mm	Width mm	Height mm
187691	K107.1	98	43	23

### K107.1

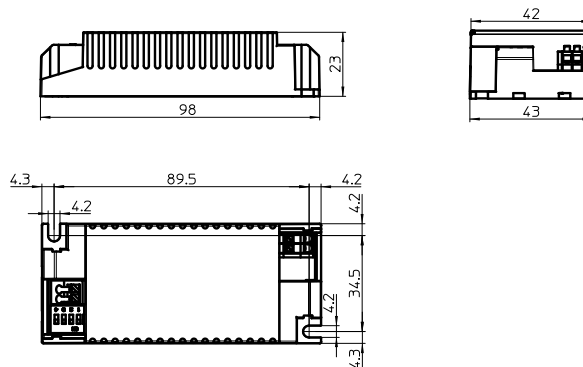

The values contained in this data sheet can change due to technical innovations. Any such changes will be made without separate notification.

## Recommended cables – Built-in operation

### Without cord grip

Input:

2x H03VVH2-F: 2x 0.5-1.5 mm<sup>2</sup>

Output:

H05VVH2-F: 2x 0.5-1.5 mm<sup>2</sup> / H05VV-F: 2x 0.5-1.5 mm<sup>2</sup>

## Recommended cables – Independent operation

### Cord grip "sl" for K107/K110

Available for independent operation

1 cord grip contains one upper and one lower part

Separately available

Input:

H03VVH2-F: 2x 0.75-1.0 mm<sup>2</sup> / H05VV-F: 2x 1.5 mm<sup>2</sup>

Output:

H03VVH2-F: 2x 0.5-1.0 mm<sup>2</sup> / H05VV-F: 2x 1.5 mm<sup>2</sup>

**Best.-Nr.: 187450** (1 pcs. cord grip sl for K107/K110)

Packaging unit: 20 pcs. (suffix -1702) / 120 pcs. (suffix -1703)

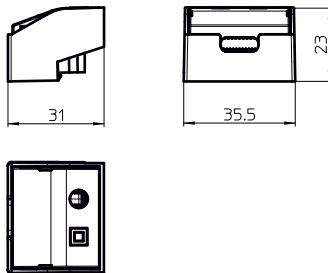

### Cord grip "ws" for K107/K110

Available for independent operation

1 cord grip contains one upper and one lower part and a screw

Separately available

Input:

H03VVH2-F: 2x 0.5-0.75 mm<sup>2</sup>

Output:

H03VVH2-F: 2x 0.5-1.0 mm<sup>2</sup> / H05VV-F: 2x 1.5 mm<sup>2</sup>

**Best.-Nr.: 187451** (1 pcs. cord grip ws for K107/K110)

Packaging unit: 20 pcs. (suffix -1702) / 120 pcs. (suffix -1703)

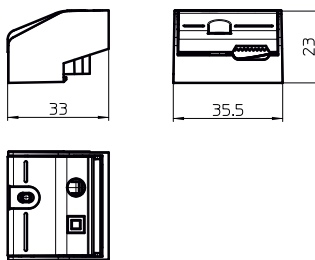

### Cord grip "LILO" for K107/K110

Available for independent operation

1 cord grip contains one upper and one lower part and two screws

Input:

2x H05VV-F: 2x 1.5 mm<sup>2</sup>

**Best.-Nr.: 187452** (1 pcs. LILO (5pin) for K107/K110)

Packaging unit: 20 pcs. (suffix -1702) / 120 pcs. (suffix -1703)

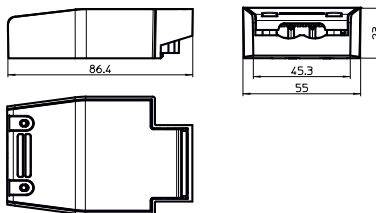

Any wires deviating from the recommendations provided in this datasheet must be professionally evaluated, tested, and approved prior to use in the intended application.

The values contained in this data sheet can change due to technical innovations. Any such changes will be made without separate notification.

## Electrical characteristics

Max. output W	Type	Ref. No.	Voltage 50–60 Hz V	Mains current mA	Inrush current A / $\mu$ s	Current output DC mA ( $\pm$ 5%; for 14W $\pm$ 7,5%)	Voltage output DC (V)	THD at full load % (230 V)	Efficiency at full load % (230 V)	Ripple 100 Hz %
42	ECXe 1050.804	<b>187691</b>	220–240	220–201	11.8 / 41	300/350/400/450/500/550/600/650/700/750/800/850/900/950/1000/1050	9–52	< 4	91	< 1

## Maximum ratings

Exceeding the maximum ratings can lead to reduction of service life or destruction of the drivers.

Ref. No.	Ambient temperature range		Operation humidity range		Storage temperature range		Storage humidity range		Max. operation temperature at $t_c$ point °C	Degree of protection
	°C min.	°C max.	% min.	% max.	°C min.	°C max.	% min.	% max.		
187691	-20	+40	10	90	-25	+80	10	90	80	IP20

## Expected service life time

at operation temperatures at  $t_c$  point

Operation current	Ref. No.	
All	70 °C*	80 °C
hrs.	100.000	50.000

\* recommended operation temperature

## Product label

**VS LIGHTING SOLUTIONS**  
 Vossloh-Schwabe Deutschland GmbH  
 Stuttgarter Straße 61/1  
 73614 Schorndorf  
 Electronic Controlgear for LED  
**Type ECXe 1050.804**  
 Ref.-No. 187691  
 Made in China

**SEC**  $\equiv$  U<sub>rated</sub> = 9...52Vdc U<sub>out</sub> = 59Vdc  
 LED+ ■ LED- ■  
 $t_c = 80^\circ\text{C}$   
 $t_a = -20...40^\circ\text{C}$

**SELV**  $\equiv$  U<sub>N</sub> = 220...240 V  $\approx$   
 I<sub>max</sub> = 0.28 A  
 f<sub>N</sub> = 0/50/60 Hz  
 $\lambda = 0.43\text{C}...0.99$

0.5-1.5mm<sup>2</sup>

VS LIGHTING SOLUTIONS		Electronic Controlgear for LED			
Type ECXe 1050.804		Ref.-No. 187691			
DIP SETTINGS		1 2 3 4			
Rated (W)	Rated (mA)	1	2	3	4
13,6	300	-	-	-	-
18,2	350	-	-	-	ON
20,8	400	-	-	ON	-
23,4	450	-	-	ON	ON
26	500	-	ON	-	-
28,6	550	-	ON	ON	-
31,2	600	-	ON	ON	-
33,8	650	-	ON	ON	ON
36,4	700	ON	-	-	-
39	750	ON	-	-	ON
41,6	800	ON	-	ON	-
41,65	850	ON	-	ON	ON
41,4	900	ON	ON	-	-
41,8	950	ON	ON	-	ON
42	1000	ON	ON	ON	-
42	1050	ON	ON	ON	ON

## DIP Switch settings

Pin 1	Pin 2	Pin 3	Pin 4	Operation current (mA)
OFF	OFF	OFF	OFF	300
OFF	OFF	OFF	ON	350
OFF	OFF	ON	OFF	400
OFF	OFF	ON	ON	450
OFF	ON	OFF	OFF	500
OFF	ON	OFF	ON	550
OFF	ON	ON	OFF	600
OFF	ON	ON	ON	650
ON	OFF	OFF	OFF	700
ON	OFF	OFF	ON	750
ON	OFF	ON	OFF	800
ON	OFF	ON	ON	850
ON	ON	OFF	OFF	900
ON	ON	OFF	ON	950
ON	ON	ON	OFF	1000
ON	ON	ON	ON	1050

The values contained in this data sheet can change due to technical innovations. Any such changes will be made without separate notification.

## Typ. performance graphs for 187691 / Type ECXe 1050.804

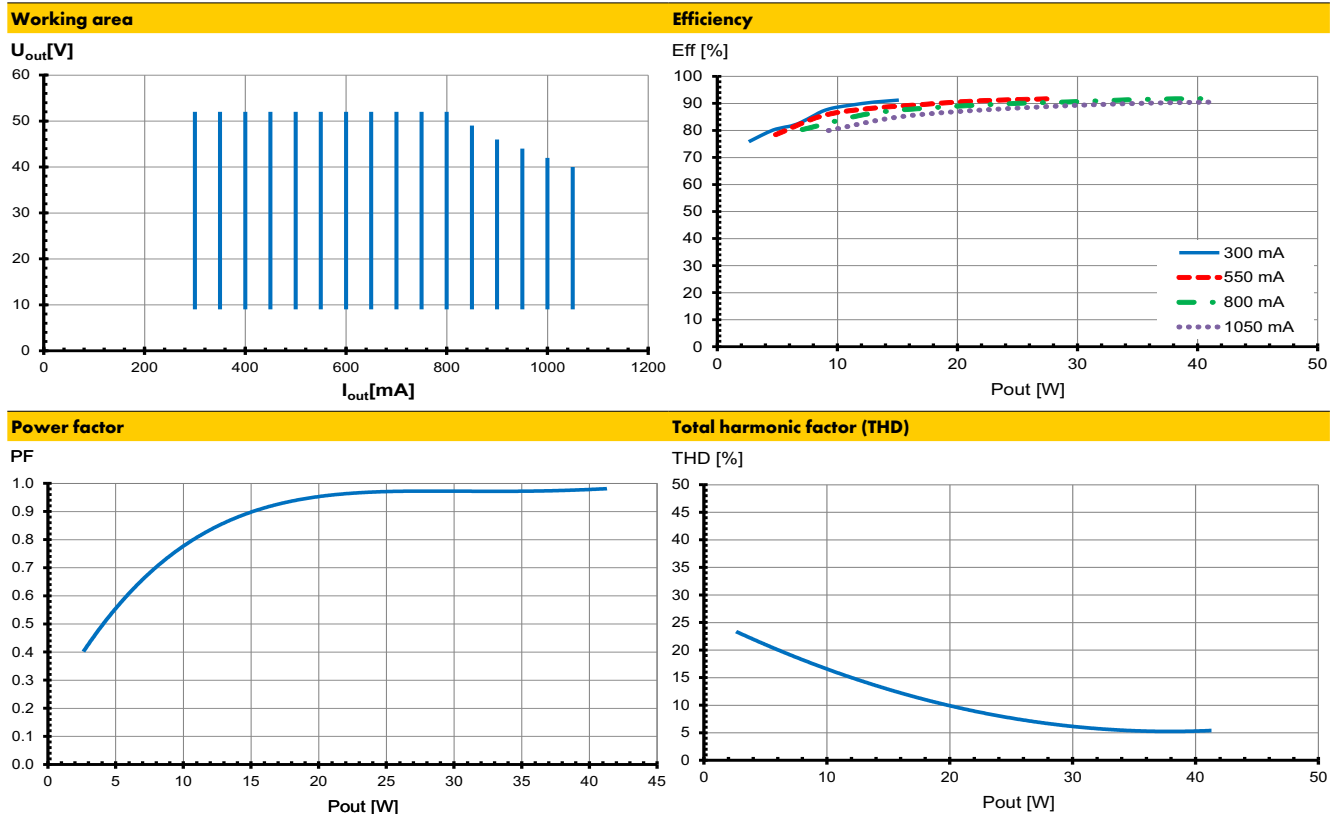

### Safety functions

- Transient mains peaks protection:
  - Values are in compliance with EN 61547 (interference immunity).
  - Surges between L–N: up to 1 kV
- Short-circuit protection: The control gear is protected against permanent short-circuit with shutdown.
- Overload protection: The control gear is protected against overload with shutdown.
  - Please check before switch-on mains power supply that the selected LED load is suitable (see Electrical Characteristics on data sheet).
- Overheating: The control gear has overheating protection. In case of overheating the control gear will reduce the power.
- No load operation: The control gear is protected against no load operation (open load).
- If any of the above mentioned safety functions will be triggered, disconnect the control gear from the power supply then find and eliminate the cause of the problem.

The values contained in this data sheet can change due to technical innovations. Any such changes will be made without separate notification.

## Assembly and Safety Information

Installation must be carried out under observation of the relevant regulations and standards. Installation must be carried out in a voltage-free state (i.e. disconnection from the mains). The following advices must be observed; non-observance can result in the destruction of the LED drivers, fire and/or other hazards.

### Mandatory regulations

- DIN VDE 0100
- EN 60598-1

### Mechanical mounting

- Mounting position: Built-in: Any position inside a luminaire is allowed  
Independent application: Drivers are allowed to use for independent applications with separate cord grip.
- Mounting location: LED drivers are designed for integration into luminaires or comparable devices.  
Independent LED drivers do not need to be integrated into a casing.  
Installation in outdoor luminaires: degree of protection for luminaire with water protection rate  $\geq 4$  (e.g. IP54 required).
- Degree of protection: IP20
- Clearance: Min. 0.10 m from walls, ceilings and insulation
- Surface: Solid and plane surface for optimum heat dissipation required.
- Heat transfer: If the driver is destined for installation in a luminaire, sufficient heat transfer must be ensured between the driver and the luminaire casing.  
LED drivers should be mounted with the greatest possible clearance to heat sources.  
During operation, the temperature measure at the driver's  $t_c$  point must not exceed the specified maximum value.
- Fastening: Using M4 screws in the designated holes
- Tightening torque: 0.2 Nm

### Electrical installation

- Connection terminals: Please see page 2/3
- Stripped length: 7–8 mm
- Wiring: The mains conductor within the luminaire must be kept short (to reduce the induction of interference).  
Mains and lamp conductors must be kept separate and if possible should not be laid in parallel to one another.  
Max. secondary side lead length: 2 m

- Polarity: Please ensure the correct polarity of the leads prior to commissioning. Reversed polarity can destroy the modules.
- Through-wiring: Is not allowed.
- Secondary load: The sum of forward voltages of LED loads is within the tolerances which are mentioned in the Electrical Characteristics on the data sheet.
- Parallel wiring: Parallel connection of LED loads is not allowed.
- Wiring diagram:

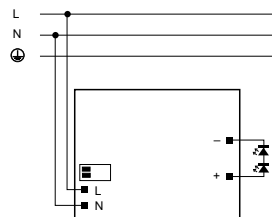

Note: Max. quantity of drivers at one push button: 30

### Selection of automatic cut-outs for VS LED drivers

- Dimensioning automatic cut-outs  
High transient currents occur when an LED driver is switched on because the capacitors have to load. Ignition of LED modules occurs almost simultaneously. This also causes a simultaneous high demand for power. These high currents when the system is switched on put a strain on the automatic conductor cut-outs, which must be selected and dimensioned to suit.
- Release reaction  
The release reaction of the automatic conductor cut-outs comply with VDE 0641 part 11 for B characteristics. The values shown in the following tables are for guidance purposes only and are subject to system-dependent change.
- No. of LED drivers  
The maximum number of VS LED drivers applies to cases where the devices are switched on simultaneously. Specifications apply to single-pole fuses. The number of permissible drivers must be reduced by 20% for multi-pole fuses. The considered circuit impedance equals 400 m $\Omega$  (approx. 20 m [2.5 mm<sup>2</sup>] of conductor from the power supply to the distributor and a further 15 m to the luminaire).

Type	Ref. No.	Automatic cut-out type and possible no. of VS drivers pcs.					
Automatic cut-out type		B 10 A	B 13 A	B 16 A	C 10 A	C 13 A	C 16 A
ECXe 1050.804	<b>187691</b>	41	53	66	41	53	66

- To limit capacitive inrush currents the current carrying capacity of each circuit breaker (fuse) can be increased by a factor of 2.5 with the help of our ESB (Ref. No.: 149820, 149821, 149822) inrush current limiters.

The values contained in this data sheet can change due to technical innovations. Any such changes will be made without separate notification.