

VS Luminaires

Spots
Downlights
Panels
Linear Waterproof
Compact High-bay

Vossloh-Schwabe

Vossloh-Schwabe is not merely a provider of top-quality system solutions for the lighting industry, but above all makes a competent and innovative contribution to setting market trends.

Employing approximately 1000 people in more than 20 countries, Vossloh-Schwabe is represented all over the world. VS can draw on extensive resources for R&D as well as for international expansion activities.

A highly motivated workforce, comprehensive market knowledge, profound industry expertise as well as eco-awareness and environmental responsibility show Vossloh-Schwabe to be a reliable partner for the provision of optimum and cost-effective lighting solutions. Vossloh-Schwabe's dedication to delivering superior quality is reflected in its ISO 9001 certification.

■ CUSTOMISED SOLUTIONS

Your project, our solution

We collaborate with our customers and pay attention to their needs in order to develop customised lighting solutions. Whether the task involves the realisation of a single LED module or the creation of a turnkey system, our advanced R&D departments ensure the wishes of our customers come true.

R&D – Ideas take shape

Our R&D departments are constantly engaged in testing new materials and innovative technologies in order to offer cutting-edge solutions to create optimum lighting conditions. Using product ideas provided by our customers as a basis, our R&D teams design bespoke solutions that suit the given requirements, that can later be finessed into detailed features and ultimately guide the implementation process to create the customised product.

One stop, one shop – In-house creation of complete products

We offer complete solutions that are made entirely within the Vossloh-Schwabe Group using perfectly matched components with very high efficiency ratings.

In-house photometric testing

All necessary photometric tests can be carried out at VS. Cutting-edge equipment is used to measure all optical, chromatic and radiometric values as well as to carry out thermal simulations. These kinds of thermal and optical simulations can help to gear the development of a lighting solution to suit the respective customer specific applications at a very early stage in the planning process. The continuous monitoring process during every single project development step allows us to ensure top quality standards.



Know-how and global presence at your disposal

Using our experience and expertise, we carefully assist our customers – from first prototype production straight through to the final product. In addition, our consolidated production processes make for a highly flexible manufacturing service, enabling anything from just a few pieces right up to a mass production. Moreover, our widespread global presence reflects the importance we attach to staying close to both our customers and the market, which allows us to provide first-class customer and highly efficient logistics services.

www.vossloh-schwabe.com

Contents



Spots for furnitures and shelves 4-7

- FlatLine 4
- SoftLine 4
- SmartLine 5
- StartLine 6
- IPLine 6
- Tiny 7



Downlights 8-9

- Downlights Prime K C 8
- Downlights EasyLine 9



Panels 10-11

- Flat Panels Comfort with or without external driver 10
- Backlight Panels with or without external driver 11



Linear Waterproof 12-13

- Linear Waterproof PrimLine 12
- Linear Waterproof ComfortLine 12
- Linear Waterproof EasyLine 13



Compact High-bay 14

- Compact High-bay EasyLine 14



LED operating devices 15



SoftLine and FlatLine

Complete LEDSpot equipped with optics and metal frame

Constant-current or constant-voltage operation
 Material: metal frame, silver or white / diffuse cover
 For cut-out: Ø 56 mm
 Fastening: snap-in clips or springs for easy installation
 Degree of protection: SoftLine IP40 / FlatLine IP20 (front part IP44)
 Use of external LED operating device is required (see page 15).



LED SPOTS

SoftLine

Ref. No.	Type	Frame colour	CCT	Beam angle	Typ. lumen*	Input voltage	Max. power*	Energy efficiency
563861	LCH032	silver	2580...2870 K	90°	205 lm	24 V	2.8 W	A++
563863	LCH032	silver	2870...3220 K	90°	225 lm	24 V	2.8 W	A++
563865	LCH032	silver	3710...4260 K	90°	225 lm	24 V	2.8 W	A++
563862	LCH032	white	2580...2870 K	90°	205 lm	24 V	2.8 W	A++
563864	LCH032	white	2870...3220 K	90°	225 lm	24 V	2.8 W	A++
563866	LCH032	white	3710...4260 K	90°	225 lm	24 V	2.8 W	A++
563336	LCH032	silver brushed	2580...2870 K	90°	205 lm	24 V	2.8 W	A++
562742	LCH032	silver brushed	2870...3220 K	90°	225 lm	24 V	2.8 W	A++
562885	LCH032	silver brushed	3710...4260 K	90°	225 lm	24 V	2.8 W	A++
562753	LCH033	silver brushed	2870...3220 K	90°	225 lm	12 V	2.8 W	A++
562754	LCH033	silver brushed	3710...4260 K	90°	225 lm	12 V	2.8 W	A++

* Production tolerance of luminous flux and power consumption: ±10%

FlatLine CV / TW (silver frame)

Ref. No.	Type	CCT	Beam angle	Typ. lumen*	Input voltage	Max. power*	Energy efficiency
569401	LCH-49 TW	2700 K	70°	165 lm	12 V	2.4 W	A+
		4000 K		175 lm			
561588	LCH028	2870...3200 K	60°	110 lm	12 V	1.4 W	A++
561590	LCH028	3850...4250 K	60°	110 lm	12 V	1.4 W	A++

* Production tolerance of luminous flux and power consumption: ±10%

Cable set for FlatLine (LCH028)

Leads: Cu tinned, stranded conductors AWG22, PVC-insulation, lengths: 250 mm

Ref. No.: 561868

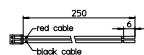

SoftLine

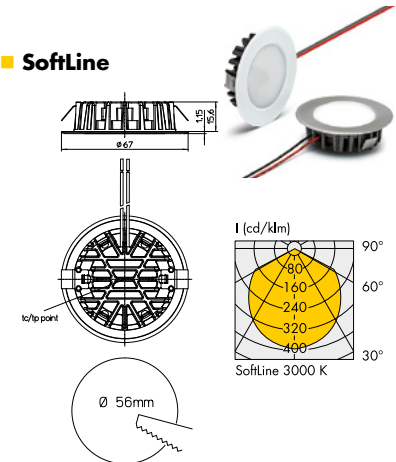

FlatLine LCH-49 TW

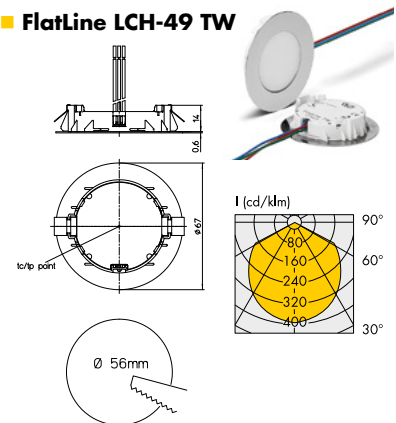

FlatLine LCH028

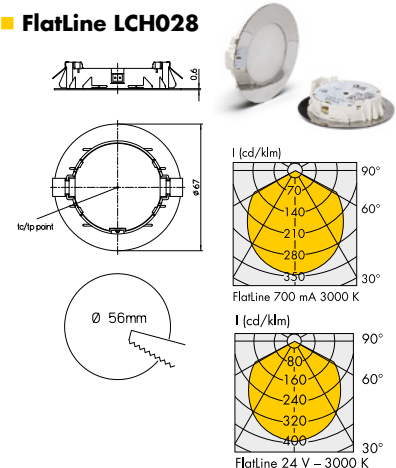

SmartLine COB / SMD

Complete LEDSpot equipped with optics, heat sink, leads and metal frame

Constant-current or constant-voltage operation

Material: metal frame, silver or white / diffuse cover

For cut-out: Ø 56 mm

Fastening: snap-in clips or springs for easy installation

Use of external LED operating device is required (see page 15).

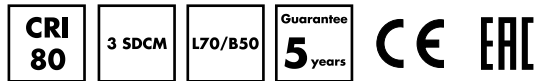

LED SPOTS

SmartLine COB

Operating current: 350 mA, typ. voltage: 9 V, max. power*: 3.15 W

Ref. No.	Type	Frame shape	Frame colour	CCT	Beam angle	Typ. lumen*	Energy efficiency
564645	LCH-017	round	silver	3000 K	40°	310 lm	A++
564648	LCH-017	round	silver	4000 K	40°	330 lm	A++
564647	LCH-017	round	white	3000 K	40°	310 lm	A++
564649	LCH-017	round	white	4000 K	40°	330 lm	A++
564655	LCH-020	square	silver	3000 K	40°	310 lm	A++
564657	LCH-020	square	silver	4000 K	40°	330 lm	A++
564656	LCH-020	square	white	3000 K	40°	310 lm	A++
564658	LCH-020	square	white	4000 K	40°	330 lm	A++
564650	LCH-019	round	silver	3000 K	40°	310 lm	A++
564652	LCH-019	round	silver	4000 K	40°	330 lm	A++
564651	LCH-019	round	white	3000 K	40°	310 lm	A++
564653	LCH-019	round	white	4000 K	40°	330 lm	A++
564659	LCH-021	square	silver	3000 K	40°	310 lm	A++
564661	LCH-021	square	silver	4000 K	40°	330 lm	A++
564660	LCH-021	square	white	3000 K	40°	310 lm	A++
564662	LCH-021	square	white	4000 K	40°	330 lm	A++

* Production tolerance of luminous flux and power consumption: ±10%

SmartLine SMD 12 V DC

Ref. No.	Type	Frame shape	Frame colour	CCT	Beam angle	Typ. lumen*	Max. power*	Energy efficiency
569249	LCH-051	round	silver	3000 K	36°	155 lm	2 W	A++
568262	LCH-051	round	silver	4000 K	36°	160 lm	2 W	A++

* Production tolerance of luminous flux and power consumption: ±10%

SmartLine COB

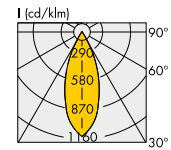
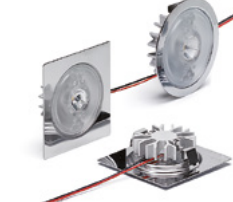

LCH-017

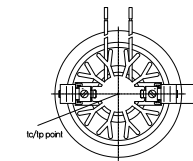
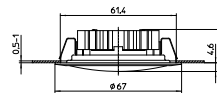

LCH-020

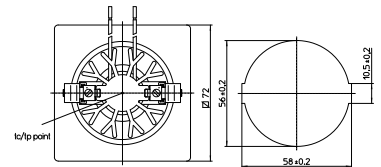
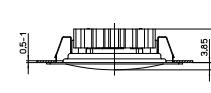

LCH-019

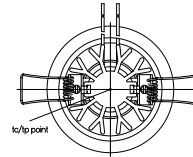
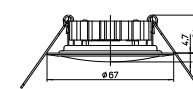

LCH-021

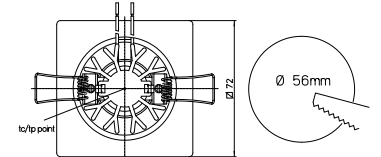
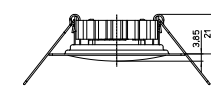

SmartLine SMD



LCH-051

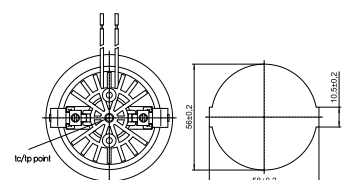
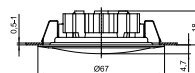

StartLine SMD and IPLine COB

Complete LEDSpot equipped with optics, heat sink, leads and frame

Constant-current or constant-voltage operation
 Material: metal frame, silver or white
 For cut-out: \varnothing 56 mm
 Fastening: snap-in clips for easy installation
 Degree of protection: StartLine IP20 (front part IP40) / IPLine IP54
 Use of external LED operating device is required (see page 15).

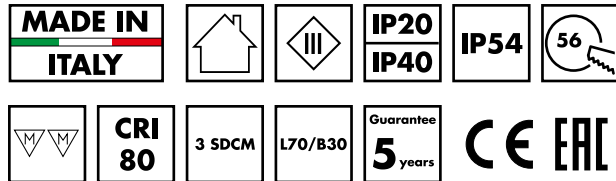

LED SPOTS

StartLine SMD 12 V DC

Ref. No.	Type	Frame colour	CCT	Beam angle	Typ. lumen*	Input voltage	Max. power*	Energy efficiency
569251	LCH-052	silver	3000 K	38°	125 lm	12 V	2 W	A+
568263	LCH-052	silver	4000 K	38°	140 lm	12 V	2 W	A++

* Production tolerance of luminous flux and power consumption: $\pm 10\%$



StartLine LCH-052

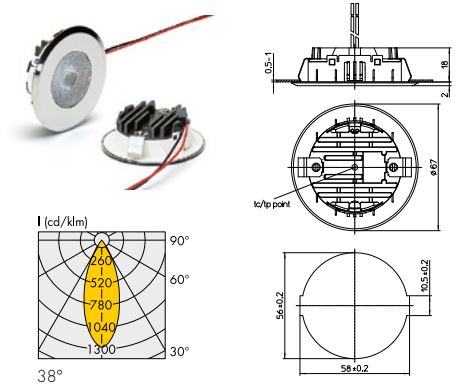

IPLine COB

Reflector with clear glass

Ref. No.	Type	Frame colour	CCT	Beam angle	Typ. lumen*	Operating current	Typ. voltage	Max. power*	Energy efficiency
564771	LCH-023	silver	3000 K	40°	310 lm	350 mA	9 V	3.15 W	A++
564773	LCH-023	silver	4000 K	40°	330 lm	350 mA	9 V	3.15 W	A++
564770	LCH-023	white	3000 K	40°	310 lm	350 mA	9 V	3.15 W	A++
564772	LCH-023	white	4000 K	40°	330 lm	350 mA	9 V	3.15 W	A++

* Production tolerance of luminous flux and power consumption: $\pm 10\%$



IPLine LCH-023

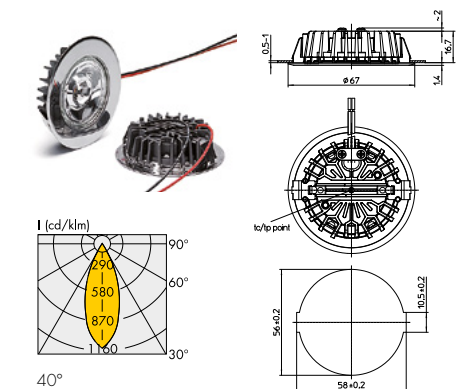

Tiny

Complete LEDSpot equipped with optics, leads and metal frame

Constant-current or constant-voltage operation

Material: metal frame, silver or white

For cut-out: Ø 26 mm

Fastening: snap-in plastic clips for easy installation

Beam angle: 36°

Use of external LED operating device is required (see page 15).

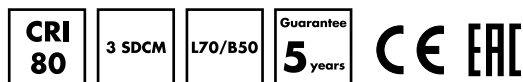

Tiny

Ref. No.	Type	Frame colour	CCT	Typ. lumen*	Operating current	Typ. voltage	Max. power*	Energy efficiency
563913	LCH-044	silver	3000 K	130 lm	350 mA	2.8 V	0.98 W	A++
563915	LCH-044	silver	4500 K	140 lm	350 mA	2.8 V	0.98 W	A++
565884	LCH-044	white	3000 K	130 lm	350 mA	2.8 V	0.98 W	A++
565885	LCH-044	white	4500 K	140 lm	350 mA	2.8 V	0.98 W	A++

* Production tolerance of luminous flux and power consumption: ±10%

Tiny Kit – For installation of 3–5 Tiny spots

Plug and Play kit for easy and fast connection

Consisting of constant-current LED driver 186341 and 5 Tiny spots with white frame (the number of spots can be reduced to three) and connection cables

Total power consumption of the kit: 6.6 W

Ref. No.: 566611 3000 K

Ref. No.: 568434 4500 K

Tiny 12 V DC

Ref. No.	Type	Frame colour	CCT	Typ. lumen*	Input supply	Max. power*	Energy efficiency
569263	LCH-050	silver	3000 K	100 lm	12 V	1.1 W	A++
568264	LCH-050	silver	4000 K	105 lm	12 V	1.1 W	A++
569264	LCH-050	white	3000 K	100 lm	12 V	1.1 W	A++
569265	LCH-050	white	4000 K	105 lm	12 V	1.1 W	A++

* Production tolerance of luminous flux and power consumption: ±10%

LED SPOTS

Tiny CC

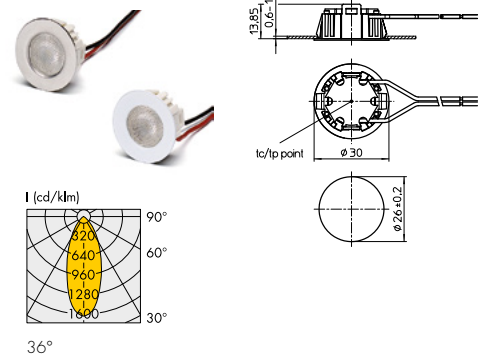

Tiny Kit



Tiny CV

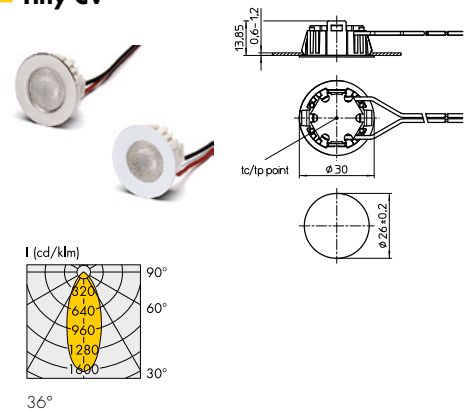

Downlight Prime K C - 4" / 6" / 8"

Indoor LED recessed mounted downlight with aluminium reflector

High quality COB technology

Material: aluminium diecast, powder coating: epoxid

Front part: glass

Flange colour: white (RAL 9003)

Fastening: snap-in clips for easy installation

Use of external LED constant current driver is required (see page 15).

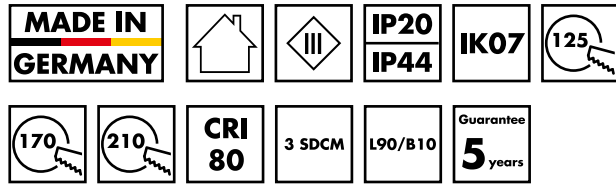

Prime K C 4"

Operating current: 350–700 mA, voltage range: 30–40 V DC

Ref. No.	Glass	Reflector Ø	CCT	Beam angle	Typ. lumen* at 700 mA	Max. power* at 700 mA
570405	clear	118 mm	3000 K	20°	2830 lm	24.4 W
570406	clear	118 mm	4000 K	20°	2910 lm	24.4 W
570407	clear	118 mm	5000 K	20°	2970 lm	24.4 W
570408	diffuse	118 mm	3000 K	45°	2535 lm	24.4 W
570409	diffuse	118 mm	4000 K	45°	2610 lm	24.4 W
570410	diffuse	118 mm	5000 K	45°	2665 lm	24.4 W



Prime K C 6"

Operating current: 350–700 mA, voltage range: 30–40 V DC

Ref. No.	Glass	Reflector Ø	CCT	Beam angle	Typ. lumen* at 700 mA	Max. power* at 700 mA
570414	clear	165 mm	3000 K	20°	2910 lm	24.4 W
570415	clear	165 mm	4000 K	20°	2995 lm	24.4 W
570416	clear	165 mm	5000 K	20°	3055 lm	24.4 W
570417	diffuse	165 mm	3000 K	45°	2660 lm	24.4 W
570418	diffuse	165 mm	4000 K	45°	2740 lm	24.4 W
570419	diffuse	165 mm	5000 K	45°	2795 lm	24.4 W



Prime K C 8"

Operating current: 700–1400 mA, voltage range: 30–42 V DC

Ref. No.	Glass	Reflector Ø	CCT	Beam angle	Typ. lumen* at 1400 mA	Max. power* at 1400 mA
570423	clear	206 mm	3000 K	70°	5220 lm	51 W
570424	clear	206 mm	4000 K	70°	5375 lm	51 W
570425	clear	206 mm	5000 K	70°	5480 lm	51 W
570426	diffuse	206 mm	3000 K	88°	4560 lm	51 W
570427	diffuse	206 mm	4000 K	88°	4695 lm	51 W
570428	diffuse	206 mm	5000 K	88°	4785 lm	51 W

* Production tolerance of luminous flux and power consumption: ±10%



DOWNLIGHTS

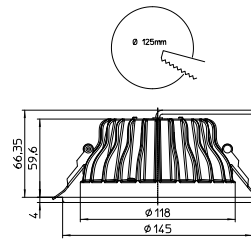

■ Prime K C 4"

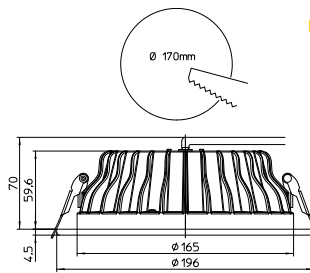
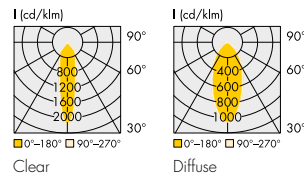

■ Prime K C 6"

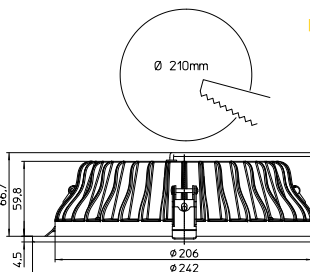
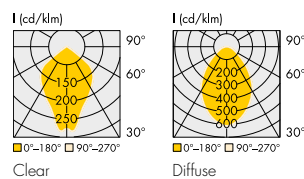

■ Prime K C 8"

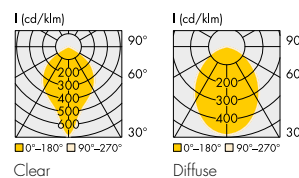

Downlight EasyLine

Indoor LED recessed mounted downlight with integrated LED driver and connection box for direct connection to mains voltage

High quality SMD technology

Material: PC (casing and diffuser)

Flange colour: white (RAL 9003)

Beam angle: 100°

Fastening: springs for easy installation



DOWNLIGHTS

■ DL-E-90



■ DL-E-105



■ DL-E-105



■ DL-E-140



■ DL-E-165



■ DL-E-190



■ DL-E-215

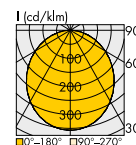

Ref. No.	Type	CCT	Typ. lumen*	Typ. power*	Energy efficiency
570271	DL-E-90	3000 K	300 lm	4 W	A+
570272	DL-E-90	4000 K	310 lm	4 W	A+
570273	DL-E-90	6500 K	325 lm	4 W	A+
570274	DL-E-105	3000 K	450 lm	6 W	A+
570275	DL-E-105	4000 K	460 lm	6 W	A+
570276	DL-E-105	6500 K	475 lm	6 W	A+
570277	DL-E-115	3000 K	600 lm	8 W	A+
570278	DL-E-115	4000 K	610 lm	8 W	A+
570279	DL-E-115	6500 K	625 lm	8 W	A+
570280	DL-E-140	3000 K	900 lm	12 W	A
570281	DL-E-140	4000 K	940 lm	12 W	A+
570282	DL-E-140	6500 K	960 lm	12 W	A+
570283	DL-E-165	3000 K	1200 lm	16 W	A
570284	DL-E-165	4000 K	1250 lm	16 W	A+
570285	DL-E-165	6500 K	1300 lm	16 W	A+
570286	DL-E-190	3000 K	1500 lm	20 W	A
570287	DL-E-190	4000 K	1550 lm	20 W	A+
570288	DL-E-190	6500 K	1590 lm	20 W	A+
570289	DL-E-215	3000 K	2000 lm	24 W	A+
570290	DL-E-215	4000 K	2050 lm	24 W	A+
570291	DL-E-215	6500 K	2080 lm	24 W	A+

* Production tolerance of luminous flux and power consumption: ±10%

Type	Ø D1 mm	Ø D2 mm	H mm	H1 mm
DL-E-90	70	90	34	2
DL-E-105	85	105	35.5	2.5
DL-E-115	95	115	41.85	2.25
DL-E-140	120	140	44.5	2.5
DL-E-165	145	165	44.5	2.5
DL-E-190	170	190	46.5	2.5
DL-E-215	195	215	46.5	2.5

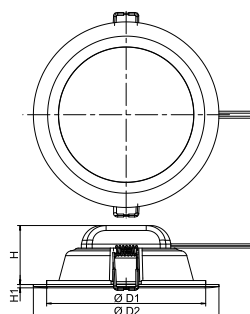

LED FlatPanel ComfortLine

Built-in LED light panel

Material: light diffuser: PMMA / PC (TPa)
 Frame colour: white (RAL 9003)
 Fastening: mounting clips, suspension or surface mounting frame
 Degree of protection: IP40 (IP54 on request)
 Use of external LED constant current driver (max. 1400 mA) is required.



FLAT PANELS



AC

Kit incl. VS LED driver 186894 (IP20)

Ref. No.	Type	IP	CCT	Beam angle	Typ. lumen*	Typ. power*	Typ. UGR 4H-8H	Energy efficiency
569234	FPC-6060	IP40	3000 K	120°	4200 lm	36 W	22	A+
569235	FPC-6060	IP40	4000 K	120°	4320 lm	36 W	22	A+
569238	FPC-6262	IP40	3000 K	120°	4200 lm	36 W	22	A+
569239	FPC-6262	IP40	4000 K	120°	4320 lm	36 W	22	A+
569236	FPC-6060	IP40	3000 K	90°	4100 lm	36 W	19	A+
569237	FPC-6060	IP40	4000 K	90°	4200 lm	36 W	19	A+
569972**	FPC-6060	IP40	4000 K	90°	4200 lm	36 W	19	A+
569240	FPC-6262	IP40	3000 K	90°	4100 lm	36 W	19	A+
569241	FPC-6262	IP40	4000 K	90°	4200 lm	36 W	19	A+

* Production tolerance of luminous flux and power consumption: ±10%

** Light diffuser material TPa approved; BS 2782-0: 2004 (TUV)

Without LED driver (see page 15)

Max. operating current: 1200 mA, voltage range: 25–30 V DC

Ref. No.	Type	IP	CCT	Beam angle	Typ. lumen* at 1200 mA	Typ. power* at 1200 mA	Typ. UGR 4H-8H	Energy efficiency
570059	FPC-6060	IP40	3000 K	120°	4200 lm	32 W	22	A+
570060	FPC-6060	IP40	4000 K	120°	4320 lm	32 W	22	A+
570063	FPC-6262	IP40	3000 K	120°	4200 lm	32 W	22	A+
570064	FPC-6262	IP40	4000 K	120°	4320 lm	32 W	22	A+
570061	FPC-6060	IP40	3000 K	90°	4100 lm	32 W	19	A+
570062	FPC-6060	IP40	4000 K	90°	4200 lm	32 W	19	A+
570065	FPC-6262	IP40	3000 K	90°	4100 lm	32 W	19	A+
570066	FPC-6262	IP40	4000 K	90°	4200 lm	32 W	19	A+

* Production tolerance of luminous flux and power consumption: ±10%

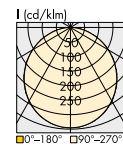

Standard

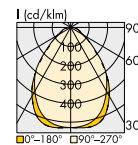

UGR 19

FPC-6060

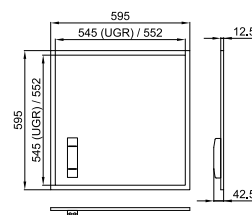

FPC-6262

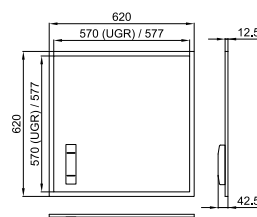

Assembly kit for suspension version

Consisting of

- 4 fixation brackets, incl. screws
- 6 screws M3, incl. pegs
- 4 steel cables with snap hooks
- 2 steel cables for suspension with adjustment element

Ref. No.: 565559



Mounting clips

For ceiling with thickness: max. 20 mm

Ref. No.: 567818 4 steel clips

Ref. No.: 567819 6 steel clips



Surface mounting frames

Material: aluminium, colour: white (RAL 9003)

Magnetic catch

For type FPC-6060

Ref. No.: 567820

For type FPC-6262

Ref. No.: 567821



LED BacklightPanel EasyLine

Built-in LED light panel

Material: frame: aluminium, casing: metal (SPCC),
light diffuser: PC, lens: PMMA
Frame colour: white (RAL 9003)
Fastening: mounting clips, suspension or
surface mounting frame
Degree of protection: IP40



BACKLIGHT PANELS



AC

Kit incl. integrated LED driver



Ref. No.	Type	IP panel	CCT	Beam angle	Typ. lumen*	Typ. power*	Typ. UGR 4H-8H	Energy efficiency
570086	BP-6060	IP40	3000 K	120°	3910 lm	34 W	22	A+
570087	BP-6060	IP40	4000 K	120°	4080 lm	34 W	22	A+
570088	BP-6262	IP40	3000 K	120°	3910 lm	34 W	22	A+
570089	BP-6262	IP40	4000 K	120°	4080 lm	34 W	22	A+
570090	BP-12030	IP40	3000 K	120°	3910 lm	34 W	22	A+
570091	BP-12030	IP40	4000 K	120°	4080 lm	34 W	22	A+
570092	BP-6060	IP40	3000 K	90°	3860 lm	34 W	19	A+
570093	BP-6060	IP40	4000 K	90°	4070 lm	34 W	19	A+
570094	BP-6262	IP40	3000 K	90°	3860 lm	34 W	19	A+
570095	BP-6262	IP40	4000 K	90°	4070 lm	34 W	19	A+
570096	BP-12030	IP40	3000 K	90°	3860 lm	34 W	19	A+
570097	BP-12030	IP40	4000 K	90°	4070 lm	34 W	19	A+

* Production tolerance of luminous flux and power consumption: ±10%

Without LED driver (see page 15)

Max. operating current: 750 mA, voltage range: 37–45 V DC



Ref. No.	Type	IP panel	CCT	Beam angle	Typ. lumen*	Typ. power*	Typ. UGR 4H-8H	Energy efficiency
570074	BP-6060	IP40	3000 K	120°	3910 lm	30 W	22	A+
570075	BP-6060	IP40	4000 K	120°	4080 lm	30 W	22	A+
570076	BP-6262	IP40	3000 K	120°	3910 lm	30 W	22	A+
570077	BP-6262	IP40	4000 K	120°	4080 lm	30 W	22	A+
570078	BP-12030	IP40	3000 K	120°	3910 lm	30 W	22	A+
570079	BP-12030	IP40	4000 K	120°	4080 lm	30 W	22	A+
570080	BP-6060	IP40	3000 K	90°	3860 lm	30 W	19	A+
570081	BP-6060	IP40	4000 K	90°	4070 lm	30 W	19	A+
570082	BP-6262	IP40	3000 K	90°	3860 lm	30 W	19	A+
570083	BP-6262	IP40	4000 K	90°	4070 lm	30 W	19	A+
570084	BP-12030	IP40	3000 K	90°	3860 lm	30 W	19	A+
570085	BP-12030	IP40	4000 K	90°	4070 lm	30 W	19	A+

* Production tolerance of luminous flux and power consumption: ±10%

Suspension kit

Length: 1.5 m

Consisting of

- 4 fixation brackets
- 8 fixing screws M3
- 6 screws M4, incl. pegs

Ref. No.: 570320



Mounting clips

For ceiling with thickness: max. 20 mm

Set of 4 mounting clips

Ref. No.: 570321

Safety rope kit

Length: 1.5 m

- 1 fixing bracket
- 2 fixing screws M3

Ref. No.: 570322

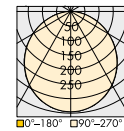

Standard

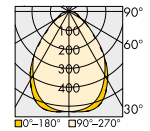

UGR 19

BP-6060

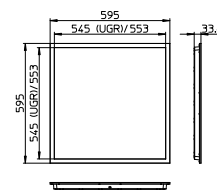

BP-6262

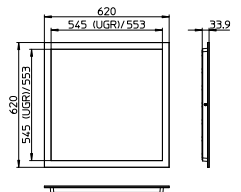

BP-12030

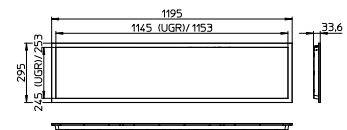

Surface mounting frames

Only for panels with integrated drivers

Material: aluminium, colour: white (RAL 9003)

Magnetic catch

For type BP-6060

Ref. No.: 567820

For type BP-6262

Ref. No.: 567821



LED Linear Waterproof ComfortLine / PrimeLine

Wet room LED light

Material: PC
 Colour: grey, for casing RAL 7035, for end caps RAL 7046
 Degree of protection: IP66
 Fastening: mounting brackets or suspension springs
 Fire protection: V2 (UL94)
 Glowwire test: 850 °C
 Beam angle: 120°
 Different versions: Standard and through-wiring
 With integrated LED driver.



LINEAR WATERPROOF



ComfortLine

Ref. No.	Through-wiring	Type	CCT	Typ. lumen*	Typ. power*	Energy efficiency
570157	—	WP-600-C	4000 K	2100 lm	21 W	A+
569347	569348	WP-1200-C	4000 K	4200 lm	37 W	A+
569355	569357	WP-1200-C	5000 K	4300 lm	37 W	A+
569356	569358	WP-1200-C	6500 K	4200 lm	37 W	A+
569349	569350	WP-1500-C	4000 K	5700 lm	51 W	A+
569359	569361	WP-1500-C	5000 K	5800 lm	51 W	A+
569360	569362	WP-1500-C	6500 K	5700 lm	51 W	A+

* Production tolerance of luminous flux and power consumption: ±10%

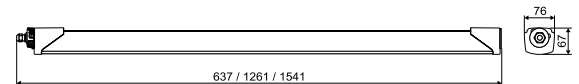

PrimeLine

Ref. No.	Through-wiring	Type	CCT	Typ. lumen*	Typ. power*	Energy efficiency
569351	569352	WP-1200-P	4000 K	4000 lm	29 W	A++
569313	569315	WP-1200-P	5000 K	4000 lm	29 W	A++
569314	569316	WP-1200-P	6500 K	4000 lm	29 W	A++
569353	569354	WP-1500-P	4000 K	6000 lm	44 W	A++
569317	569319	WP-1500-P	5000 K	6000 lm	44 W	A++
569318	569320	WP-1500-P	6500 K	6000 lm	44 W	A++

* Production tolerance of luminous flux and power consumption: ±10%

Anti-theft device

Material: plastics
 Packaging unit: 4 pcs.
 Type: WP Anti-theft
Ref. No.: 570158



LED Linear Waterproof EasyLine

Wet room LED light

Material: PC
 Colour: white, for casing RAL 9003
 Fastening: mounting brackets
 Degree of protection: IP65
 Beam angle: 130°
 Different versions: Standard, through-wiring, emergency lighting
 With integrated LED driver.



LINEAR WATERPROOF



EasyLine



Ref. No.	Through-wiring	Type	CCT	Typ. lumen*	Typ. power*	Energy efficiency
570572	570574	WP-E-600	4000 K	2400 lm	20 W	A+
570573	570575	WP-E-600	6500 K	2500 lm	20 W	A+
570576	570580	WP-E-1200	4000 K	4800 lm	40 W	A+
570577	570581	WP-E-1200	6500 K	4900 lm	40 W	A+
570578**	570582**	WP-E-1200	4000 K	4800 lm	40 W	A+
570579**	570583**	WP-E-1200	6500 K	4900 lm	40 W	A+
570584	570586	WP-E-1500	4000 K	6000 lm	50 W	A+
570585	570587	WP-E-1500	6500 K	6100 lm	50 W	A+

* Production tolerance of luminous flux and power consumption: ±10%

** LiFePO4 battery, charge time: 3 hrs., power: 3 W, 380–460 lm, max. $t_a = 40\text{ °C}$

WP-E-600

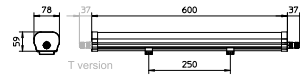

WP-E-1200

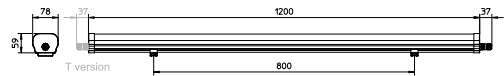

WP-E-1500

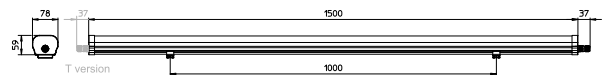

LED Compact High-bay EasyLine

For industry lighting

Mains voltage: 120–277 V
 Mains frequency: 50–60 Hz
 Material: casing: aluminium, optics: PC
 Casing colour: black
 Fastening: fixing eye
 Degree of protection: IP65
 Glowwire test: 650 °C
 Connection: with leads
 With integrated LED driver.



CB Scheme

Ref. No.	Type	CCT	Typ. lumen *	Typ. power*	Beam angle	Energy efficiency
570253	HB-E-260	4000 K	15000 lm	100 W	60°	A++
570254	HB-E-260	4000 K	15000 lm	100 W	90°	A++
570255	HB-E-260	4000 K	15000 lm	100 W	110°	A++
571264	HB-E-260	5000 K	15200 lm	100 W	60°	A++
571265	HB-E-260	5000 K	15200 lm	100 W	90°	A++
571266	HB-E-260	5000 K	15200 lm	100 W	110°	A++
570256	HB-E-260	6500 K	15300 lm	100 W	60°	A++
570257	HB-E-260	6500 K	15300 lm	100 W	90°	A++
570258	HB-E-260	6500 K	15300 lm	100 W	110°	A++
570259	HB-E-305	4000 K	22500 lm	150 W	60°	A++
570260	HB-E-305	4000 K	22500 lm	150 W	90°	A++
570261	HB-E-305	4000 K	22500 lm	150 W	110°	A++
571267	HB-E-305	5000 K	22700 lm	150 W	60°	A++
571268	HB-E-305	5000 K	22700 lm	150 W	90°	A++
571274	HB-E-305	5000 K	22700 lm	150 W	110°	A++
570262	HB-E-305	6500 K	22900 lm	150 W	60°	A++
570263	HB-E-305	6500 K	22900 lm	150 W	90°	A++
570264	HB-E-305	6500 K	22900 lm	150 W	110°	A++
570265	HB-E-343	4000 K	30000 lm	200 W	60°	A++
570266	HB-E-343	4000 K	30000 lm	200 W	90°	A++
570267	HB-E-343	4000 K	30000 lm	200 W	110°	A++
571275	HB-E-343	5000 K	30200 lm	200 W	60°	A++
571278	HB-E-343	5000 K	30200 lm	200 W	90°	A++
571280	HB-E-343	5000 K	30200 lm	200 W	110°	A++
570268	HB-E-343	6500 K	30400 lm	200 W	60°	A++
570269	HB-E-343	6500 K	30400 lm	200 W	90°	A++
570270	HB-E-343	6500 K	30400 lm	200 W	110°	A++

* Production tolerance of luminous flux and power consumption: ±10%

HIGH-BAY

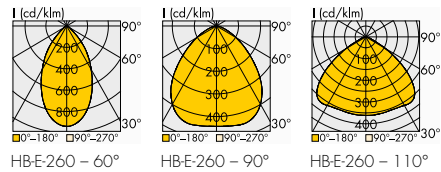
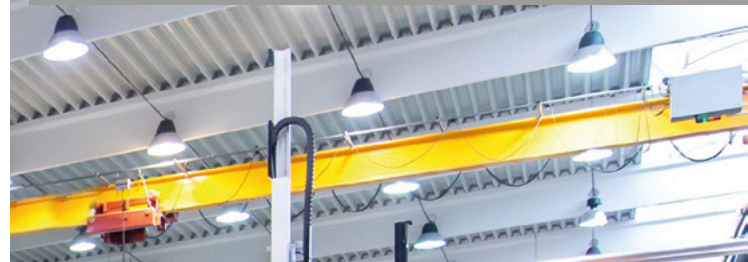

HB-E-260

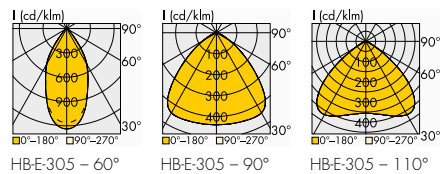

HB-E-305

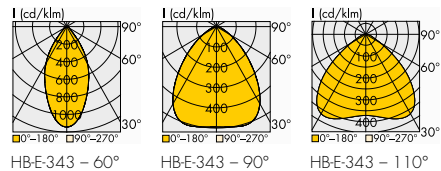

HB-E-343

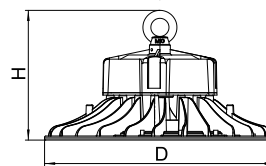
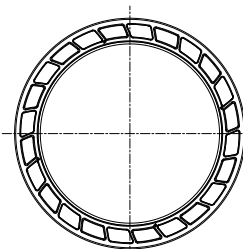

Type	∅ D mm	H mm
HB-E-260	260	164
HB-E-305	305	171
HB-E-343	343	178

LED Operating Devices

Please ensure you choose the correct LED operating devices for the chosen LED luminaire and that the respective output parameters (current, voltage, wattage) are correct.

You will find more information about our LED operating devices on our website: www.vossloh-schwabe.com

For LEDSpots CC and CV

Output supply	Max. power	Output voltage DC	Version	Casing	Dimensions LxWxH	Ref. No.
350 mA	8.75 W	3–25 V	ON/OFF	K29	65x30.7x21.5 mm	186519
350 mA	14 W	2–40 V	ON/OFF	K21	146.7x21x18 mm	186229
12 V	10 W	—	ON/OFF	K80	126.4x38x21.2 mm	186981
24 V	20 W	—	ON/OFF	K53	153x41x32 mm	187036

For Downlights Prime K C

350–700 mA, 30–40 V DC / 700–1400 mA, 30–42 V DC

Output current	Max. power	Output voltage DC	Version	Casing	Dimensions LxWxH	Ref. No.
500 mA	21 W	30–41 V	ON/OFF	K33.4	97x43x30 mm	186925*
700 mA	28 W	30–40 V	ON/OFF	K33.4	97x43x30 mm	186927*
900 mA	36 W	30–40 V	ON/OFF	K33.4	97x43x30 mm	186929*
1050 mA	42 W	31–40 V	ON/OFF	K33.4	97x43x30 mm	186930*
150–500 mA	21 W	10–42 V	DIP switch	K86	97x43x30 mm	187116
250–500 mA	21 W	25–42 V	DIP switch	K25	97x43x29.5 mm	186843**
500–700 mA	29.4 W	23–42 V	DIP switch	K25	97x43x29.5 mm	186842**
600–800 mA	32 W	28–40 V	DIP switch	K87	97x43x26 mm	187117
800–1050 mA	44.1 W	25–42 V	DIP switch	K25	97x43x29.5 mm	186841**
850–1050 mA	42 W	28–40 V	DIP switch	K87	97x43x26 mm	187119
300–1050 mA	38 W	10–36 V	DALI/PUSH / DIP switch	K33.3	146.5x43.2x30.1 mm	186763

* Cord grip 186942 for protection class II required

** Cord grip 186845 for protection class II required

For FlatPanel Comfort

max. 1200 mA, 25–30 V DC

Output current	Max. power	Output voltage DC	Version	Casing	Dimensions LxWxH	Ref. No.
350–700 mA	20–40 W	20–57 V	Rotary switch	K3	123.4x79.4x33 mm	186208
800–1050 mA	38 W	25–42 V	DIP switch	K25	97x43x29.5 mm	186841*
300–1050 mA	38 W	10–36 V	DALI	K33.3	146.5x43.2x30.1 mm	186763

* Cord grip 186845 for protection class II required

For Backlight Panel

max. 750 mA, 37–45 V DC

Output current	Max. power	Output voltage DC	Version	Casing	Dimensions LxWxH	Ref. No.
500–750	30	23–45 V	DIP switch	K25	97x43x29.5 mm	186842*
300–750	38	10–51 V	DALI / DIP switch	K33.3	146.5x43.2x30.1 mm	186763

* Cord grip 186845 for protection class II required

LED DRIVERS

K21



K25



K29



K3



K33.3



K33.4



K53



K80



K86



K87



Whenever an electric light goes on around the world, Vossloh-Schwabe is likely to have made a key contribution to ensuring that everything works at the flick of a switch.

Headquartered in Germany, Vossloh-Schwabe counts as a technology leader within the lighting sector. Top-quality, high-performance products form the basis of the company's success.

Vossloh-Schwabe's extensive product portfolio covers all lighting components: LED systems with matching control gear units, highly efficient optical systems, state-of-the-art control systems (Blu2Light and LiCS) as well as electronic and magnetic ballasts and lampholders.

The company's future is Smart Lighting.



Vossloh-Schwabe Deutschland GmbH

Hohe Steinert 8 · 58509 Luedenscheid · Germany
Phone +49 / 23 51 / 10 10 · Fax +49 / 23 51 / 10 12 17
www.vossloh-schwabe.com

VS LIGHTING SOLUTIONS

All rights reserved © Vossloh-Schwabe
Photos: VS; istockphoto.com; shutterstock.com
Technical changes are subject to change without notice
LED luminaires EN – 10/2020